



CC2640 SimpleLink™ Bluetooth® Smart Wireless MCU

1 Device Overview

1.1 Features

- Microcontroller
 - Powerful ARM® Cortex®-M3
 - EEMBC CoreMark® score: 142
 - Up to 48-MHz Clock Speed
 - 128KB of In-System Programmable Flash
 - 8-KB SRAM for Cache
 - 20-KB Ultra-Low Leakage SRAM
 - 2-Pin cJTAG and JTAG Debugging
 - Supports Over-The-Air Upgrade (OTA)
- Ultra-Low Power Sensor Controller
 - Can run autonomous from the rest of the system
 - 16-Bit Architecture
 - 2-KB Ultra-Low Leakage SRAM for Code and Data
- Efficient Code Size Architecture, Placing Drivers, Bluetooth® Low Energy Controller, and Bootloader in ROM
- RoHS-Compliant Packages
 - 4-mm x 4-mm RSM QFN32 (10 GPIOs)
 - 5-mm x 5-mm RHB QFN32 (15 GPIOs)
 - 7-mm x 7-mm RGZ QFN48 (31 GPIOs)
- Peripherals
 - All Digital Peripheral Pins can be Routed to any GPIO
 - 4 General-Purpose Timer Modules (8 x 16-Bit or 4 x 32-Bit Timer, PWM Each)
 - 12-Bit ADC, 200-ksamples/s, 8-Channel Analog MUX
 - Continuous Time Comparator
 - Ultra-Low Power Analog Comparator
 - Programmable Current Source
 - UART
 - 2x SSI (SPI, μ W, TI)
 - I²C
 - I2S
 - Real-Time Clock (RTC)
 - AES-128 Security Module
 - True Random Number Generator (TRNG)
 - 10, 15, or 31 GPIOs, Depending on Package Option
 - Support for 8 Capacitive Sensing Buttons
 - Integrated Temperature Sensor
- External System
 - On-Chip internal DC-DC Converter
 - Very Few External Components
 - Seamless Integration With the SimpleLink CC2590 and CC2592 Range Extenders
 - Pin Compatible With the SimpleLink CC13xx in 4-mm x 4-mm and 5-mm x 5-mm QFN Packages
- Low Power
 - Wide Supply Voltage Range
 - Normal Operation: 1.8 to 3.8 V
 - External Regulator Mode: 1.7 to 1.95 V
 - Active-mode RX: 5.9 mA
 - Active-mode TX at 0 dBm: 6.1 mA
 - Active-mode TX at +5 dBm: 9.1 mA
 - Active-mode MCU: 61 μ A/MHz
 - Active-mode MCU: 48.5 CoreMark/mA
 - Active-mode Sensor Controller: 8.2 μ A/MHz
 - Standby: 1 μ A (RTC Running and RAM/CPU Retention)
 - Shutdown: 100 nA (Wake-up on External Events)
- RF Section
 - 2.4 GHz RF Transceiver Compatible With Bluetooth Low Energy (BLE) 4.1 specification
 - Excellent Receiver Sensitivity (–97 dBm for BLE), Selectivity, and Blocking Performance
 - Programmable Output Power up to +5 dBm
 - Single-ended or Differential RF Interface
 - Suitable for Systems Targeting Compliance With Worldwide Radio Frequency Regulations
 - ETSI EN 300 328 (Europe)
 - EN 300 440 Class 2 (Europe)
 - FCC CFR47 Part 15 (US)
 - ARIB STD-T66 (Japan)
- Tools and Development Environment
 - Full-Feature and Low-Cost Development Kits
 - Multiple Reference Designs for Different RF Configurations
 - Packet Sniffer PC Software
 - Sensor Controller Studio
 - SmartRF™ Studio
 - SmartRF Flash Programmer 2
 - IAR Embedded Workbench® for ARM
 - Code Composer Studio™



1.2 Applications

- Home and Building Automation
 - Connected Appliances
 - Lighting
 - Locks
 - Gateways
 - Security Systems
- Industrial
 - Logistics
 - Production and Manufacturing
 - Automation
 - Asset Tracking and Management
 - Remote Display
 - Cable Replacement
 - HMI
 - Access Control
- Retail
 - Beacons
 - Advertising
 - ESL / Price Tags
 - Point of Sales / Payment Systems
- Health and Medical
 - Thermometers
 - SpO2
 - Blood Glucose and Pressure Meters
 - Weight-scales
 - Vitals Monitoring
 - Hearing Aids
- Sports and Fitness
 - Activity Monitors and Fitness Trackers
 - Heart Rate Monitors
 - Running Sensors
 - Biking Sensors
 - Sports Watches
 - Gym Equipment
 - Team Sports Equipment
- HID
 - Remote Controls
 - Keyboards and Mice
 - Gaming
- Accessories
 - Toys
 - Trackers
 - Luggage-tags
 - Wearables

1.3 Description

The CC2640 is a wireless MCU targeting *Bluetooth* Smart applications.

The device is a member of the CC26xx family of cost-effective, ultra-low power, 2.4-GHz RF devices. Very low active RF and MCU current, and low-power mode current consumption provides excellent battery lifetime and allows operation on small coin cell batteries and in energy-harvesting applications.

The CC2640 contains a 32-bit ARM Cortex-M3 running at 48-MHz as the main processor and a rich peripheral feature set, including a unique ultra-low power sensor controller, ideal for interfacing external sensors and/or collecting analog and digital data autonomously while the rest of the system is in sleep mode.

This makes the CC2640 ideal for a wide range of applications where long battery lifetime, small form factor, and ease of use is important.

The *Bluetooth* Low Energy controller is embedded into ROM and run partly on an ARM Cortex®-M0 processor. This architecture improves overall system performance and power consumption and frees up flash memory for the application.

The *Bluetooth* Smart stack is available free of charge from www.ti.com.

Device Information⁽¹⁾

PART NUMBER	PACKAGE	BODY SIZE
CC2640F128RGZ	RGZ (QFN48)	7.00 mm × 7.00 mm
CC2640F128RHB	RHB (QFN32)	5.00 mm × 5.00 mm

(1) For more information, see [Section 9, Mechanical Packaging and Orderable Information](#).

Device Information⁽¹⁾ (continued)

PART NUMBER	PACKAGE	BODY SIZE
CC2640F128RSM	RSM (QFN32)	4.00 mm x 4.00 mm

1.4 Functional Block Diagram

Section 1.4 shows a block diagram for the CC2640.

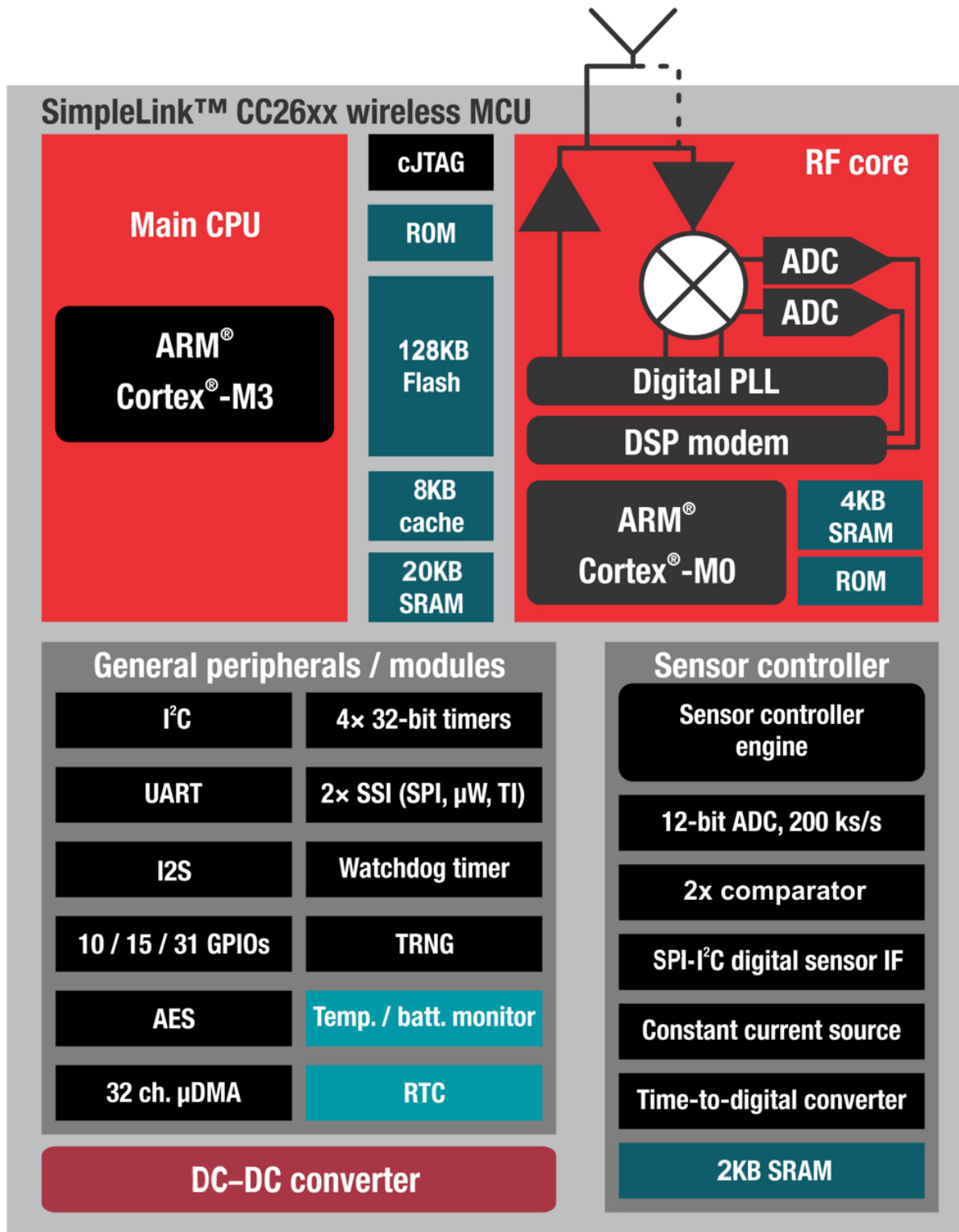

Figure 1-1. Block Diagram

Table of Contents

1 Device Overview 1	5.16 Battery Monitor 19
1.1 Features 1	5.17 Continuous Time Comparator 20
1.2 Applications 2	5.18 Low-Power Clocked Comparator 20
1.3 Description 2	5.19 Programmable Current Source 20
1.4 Functional Block Diagram 4	5.20 DC Characteristics 21
2 Revision History 6	5.21 Control Input AC Characteristics 21
3 Device Comparison 7	5.22 Synchronous Serial Interface (SSI) Characteristics 21
4 Terminal Configuration and Functions 8	5.23 Typical Characteristics 22
4.1 Pin Diagram – RSM Package 8	6 Detailed Description 25
4.2 Signal Descriptions – RSM Package 8	6.1 Overview 25
4.3 Pin Diagram – RHB Package 9	6.2 Main CPU 25
4.4 Signal Descriptions – RHB Package 10	6.3 RF Core 25
4.5 Pin Diagram – RGZ Package 11	6.4 Sensor Controller 26
4.6 Signal Descriptions – RGZ Package 11	6.5 Memory 27
5 Specifications 13	6.6 Debug 27
5.1 Absolute Maximum Ratings 13	6.7 Power Management 28
5.2 ESD Ratings 13	6.8 Clock Systems 29
5.3 Recommended Operating Conditions 13	6.9 General Peripherals and Modules 29
5.4 Thermal Characteristics 14	6.10 System Architecture 30
5.5 Electrical Characteristics 15	7 Application Circuit 31
5.6 General Characteristics 16	8 Device and Documentation Support 33
5.7 1-Mbps GFSK (<i>Bluetooth</i> Low Energy) – RX 16	8.1 Device Support 33
5.8 1-Mbps GFSK (<i>Bluetooth</i> Low Energy) – TX 17	8.2 Documentation Support 35
5.9 1-Mbps GFSK (<i>Bluetooth</i> Low Energy) – Common RX/TX 17	8.3 Additional Information 35
5.10 24-MHz Crystal Oscillator (XOSC_HF) 18	8.4 Trademarks 36
5.11 32.768-kHz Crystal Oscillator (XOSC_LF) 18	8.5 Electrostatic Discharge Caution 36
5.12 48-MHz RC Oscillator (RCOSC_HF) 18	8.6 Export Control Notice 36
5.13 32-kHz RC Oscillator (RCOSC_LF) 18	8.7 Glossary 36
5.14 ADC Characteristics 19	9 Mechanical Packaging and Orderable Information 37
5.15 Temperature Sensor 19	9.1 Packaging Information 37

2 Revision History

NOTE: Page numbers for previous revisions may differ from page numbers in the current version.

DATE	REVISION	NOTES
February 2015	*	Initial Release

3 Device Comparison

Table 3-1. Device Family Overview

Device	PHY Support	Flash (KB)	RAM (KB)	GPIO	Package ⁽¹⁾
CC2650F128xxx	Multi-Protocol ⁽²⁾	128	20	31, 15, 10	RGZ, RHB, RSM
CC2640F128xxx	<i>Bluetooth</i> low energy	128	20	31, 15, 10	RGZ, RHB, RSM
CC2630F128xxx	IEEE 802.15.4 (ZigBee [®] /6LoWPAN)	128	20	31, 15, 10	RGZ, RHB, RSM
CC2620F128xxx	IEEE 802.15.4 (RF4CE)	128	20	31, 15, 10	RGZ, RHB, RSM

(1) Package designator replaces the xxx in device name to form a complete device name, RGZ is 7-mm x 7-mm QFN48, RHB is 5-mm x 5-mm QFN32, and RSM is 4-mm x 4-mm QFN32.

(2) The CC2650 supports all PHYs and can be reflashed to run all the supported standards.

4 Terminal Configuration and Functions

NOTE

I/O pins marked in **bold** have high drive capabilities. I/O pins marked in *italics* have analog capabilities.

4.1 Pin Diagram – RSM Package

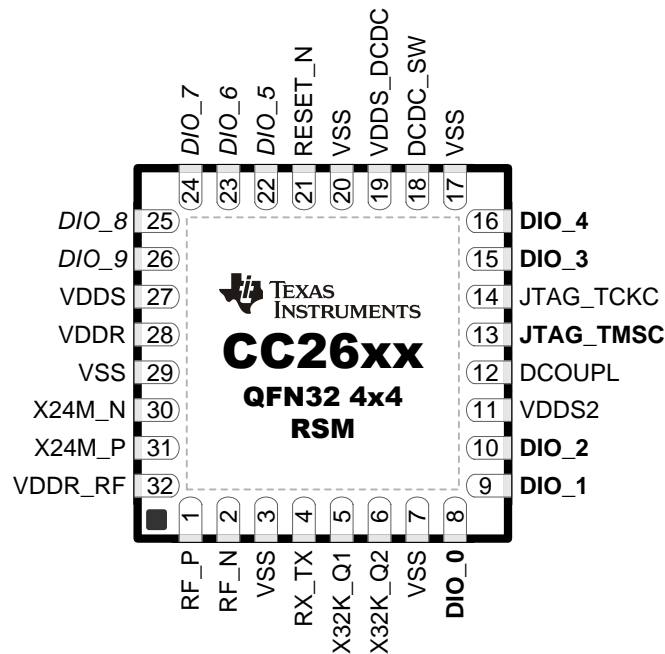

Figure 4-1. RSM (4 mm × 4 mm) Pinout, 0.4-mm Pitch

4.2 Signal Descriptions – RSM Package

Table 4-1. Signal Descriptions – RSM Package

Pin Name	Pin	Pin Type	Description
RF_P	1	RF I/O	Positive RF input signal to LNA during RX Positive RF output signal to PA during TX
RF_N	2	RF I/O	Negative RF input signal to LNA during RX Negative RF output signal to PA during TX
RX_TX	4	RF I/O	Optional bias pin for the RF LNA
VDDS	27	Power	1.8 V to 3.8 V main chip supply ⁽¹⁾
VDDS2	11	Power	1.8 V to 3.8 V GPIO supply ⁽¹⁾
VDDS_DCDC	19	Power	1.8 V to 3.8 V DC/DC supply. Tie to ground for external regulator mode (1.7 V to 1.95 V operation)
VDDR	28	Power	1.7 V to 1.95 V supply, typically connect to output of internal DC/DC ⁽²⁾⁽³⁾
VDDR_RF	32	Power	1.7 V to 1.95 V supply, typically connect to output of internal DC/DC ⁽⁴⁾⁽³⁾
DCOUP	12	Power	1.27 V regulated digital-supply decoupling capacitor ⁽³⁾
VSS	3, 7, 17, 20, 29	Power	Ground

(1) See [Section 8.2](#), technical reference manual for more details.

(2) If internal DC/DC is not used, this pin is supplied internally from the main LDO.

(3) Do not supply external circuitry from this pin.

(4) If internal DC/DC is not used, this pin must be connected to VDDR for supply from the main LDO.

Table 4-1. Signal Descriptions – RSM Package (continued)

Pin Name	Pin	Pin Type	Description
DCDC_SW	18	Power	Output from internal DC/DC ⁽¹⁾ . Tie to ground for external regulator mode (1.7 V to 1.95 V operation)
EGP		Power	Ground – Exposed Ground Pad
RESET_N	21	Digital input	Reset, active-low. No internal pullup
DIO_0	8	Digital I/O	GPIO, Sensor Controller, High drive capability
DIO_1	9	Digital I/O	GPIO, Sensor Controller, High drive capability
DIO_2	10	Digital I/O	GPIO, Sensor Controller, High drive capability
DIO_3	15	Digital I/O	GPIO, High drive capability, JTAG_TDO
DIO_4	16	Digital I/O	GPIO, High drive capability, JTAG_TDI
DIO_5	22	Digital/Analog I/O	GPIO, Sensor Controller, Analog
DIO_6	23	Digital/Analog I/O	GPIO, Sensor Controller, Analog
DIO_7	24	Digital/Analog I/O	GPIO, Sensor Controller, Analog
DIO_8	25	Digital/Analog I/O	GPIO, Sensor Controller, Analog
DIO_9	26	Digital/Analog I/O	GPIO, Sensor Controller, Analog
JTAG_TMSC	13	Digital I/O	JTAG TMSC
JTAG_TCKC	14	Digital I/O	JTAG TCKC
X32K_Q1	5	Analog I/O	32 kHz crystal oscillator pin 1
X32K_Q2	6	Analog I/O	32 kHz crystal oscillator pin 2
X24M_N	30	Analog I/O	24 MHz crystal oscillator pin 1
X24M_P	31	Analog I/O	24 MHz crystal oscillator pin 2

4.3 Pin Diagram – RHB Package

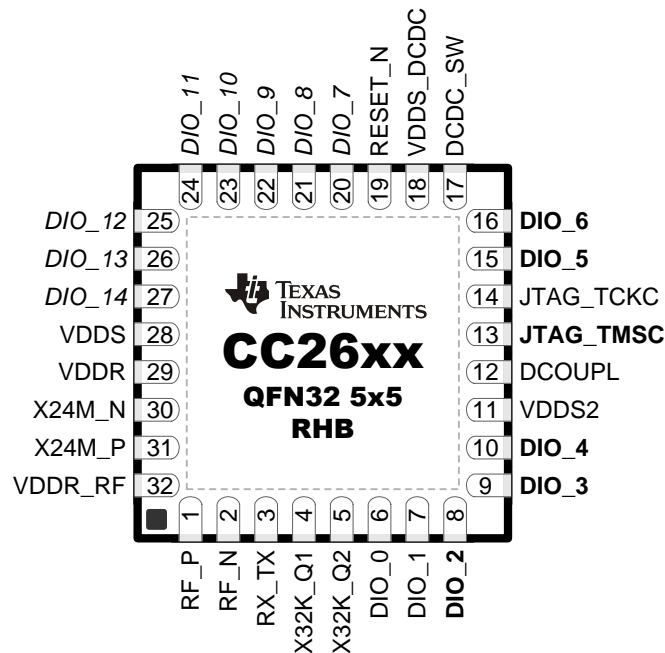

Figure 4-2. RHB (5 mm × 5 mm) Pinout, 0.5-mm Pitch

4.4 Signal Descriptions – RHB Package

Table 4-2. Signal Descriptions – RHB Package

Pin Name	Pin	Pin Type	Description
RF_P	1	RF I/O	Positive RF input signal to LNA during RX Positive RF output signal to PA during TX
RF_N	2	RF I/O	Negative RF input signal to LNA during RX Negative RF output signal to PA during TX
RX_TX	3	RF I/O	Optional bias pin for the RF LNA
VDDS	28	Power	1.8 V to 3.8 V main chip supply ⁽¹⁾
VDDS2	11	Power	1.8 V to 3.8 V GPIO supply ⁽¹⁾
VDDS_DCDC	18	Power	1.8 V to 3.8 V DC/DC supply
VDDR	29	Power	1.7 V to 1.95 V supply, typically connect to output of internal DC/DC ⁽²⁾⁽³⁾
VDDR_RF	32	Power	1.7 V to 1.95 V supply, typically connect to output of internal DC/DC ⁽⁴⁾⁽³⁾
DCOUPPL	12	Power	1.27 V regulated digital-supply decoupling ⁽³⁾
DCDC_SW	17	Power	Output from internal DC/DC ⁽¹⁾
EGP		Power	Ground – Exposed Ground Pad
RESET_N	19	Digital input	Reset, active-low. No internal pullup
DIO_0	6	Digital I/O	GPIO, Sensor Controller
DIO_1	7	Digital I/O	GPIO, Sensor Controller
DIO_2	8	Digital I/O	GPIO, Sensor Controller, High drive capability
DIO_3	9	Digital I/O	GPIO, Sensor Controller, High drive capability
DIO_4	10	Digital I/O	GPIO, Sensor Controller, High drive capability
DIO_5	15	Digital I/O	GPIO, High drive capability, JTAG_TDO
DIO_6	16	Digital I/O	GPIO, High drive capability, JTAG_TDI
DIO_7	20	Digital/Analog I/O	GPIO, Sensor Controller, Analog
DIO_8	21	Digital/Analog I/O	GPIO, Sensor Controller, Analog
DIO_9	22	Digital/Analog I/O	GPIO, Sensor Controller, Analog
DIO_10	23	Digital/Analog I/O	GPIO, Sensor Controller, Analog
DIO_11	24	Digital/Analog I/O	GPIO, Sensor Controller, Analog
DIO_12	25	Digital/Analog I/O	GPIO, Sensor Controller, Analog
DIO_13	26	Digital/Analog I/O	GPIO, Sensor Controller, Analog
DIO_14	27	Digital/Analog I/O	GPIO, Sensor Controller, Analog
JTAG_TMSC	13	Digital I/O	JTAG TMSC, High drive capability
JTAG_TCKC	14	Digital I/O	JTAG TCKC
X32K_Q1	4	Analog I/O	32 kHz crystal oscillator pin 1
X32K_Q2	5	Analog I/O	32 kHz crystal oscillator pin 2
X24M_N	30	Analog I/O	24 MHz crystal oscillator pin 1
X24M_P	31	Analog I/O	24 MHz crystal oscillator pin 2

(1) See [Section 8.2](#), technical reference manual for more details.

(2) If internal DC/DC is not used, this pin is supplied internally from the main LDO.

(3) Do not supply external circuitry from this pin.

(4) If internal DC/DC is not used, this pin must be connected to VDDR for supply from the main LDO.

4.5 Pin Diagram – RGZ Package

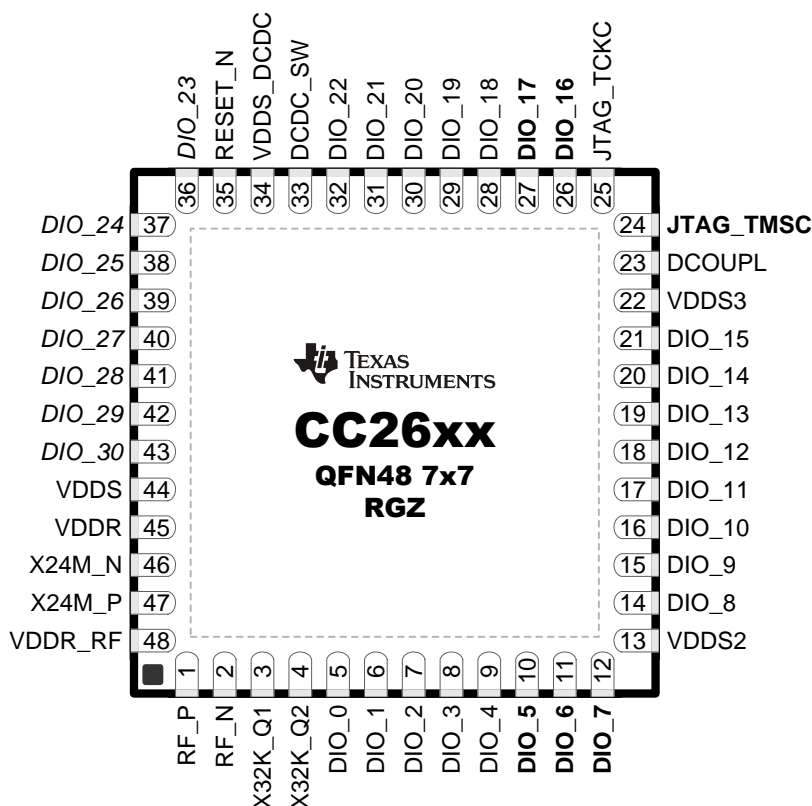

Figure 4-3. RGZ (7 mm × 7 mm) Pinout, 0.5-mm Pitch

4.6 Signal Descriptions – RGZ Package

Table 4-3. Signal Descriptions – RGZ Package

Pin Name	Pin	Pin Type	Description
RF_P	1	RF I/O	Positive RF input signal to LNA during RX Positive RF output signal to PA during TX
RF_N	2	RF I/O	Negative RF input signal to LNA during RX Negative RF output signal to PA during TX
VDDS	44	Power	1.8 V to 3.8 V main chip supply ⁽¹⁾
VDDS2	13	Power	1.8 V to 3.8 V DIO supply ⁽¹⁾
VDDS3	22	Power	1.8 V to 3.8 V DIO supply ⁽¹⁾
VDDS_DCDC	34	Power	1.8 V to 3.8 V DC/DC supply
VDDR	45	Power	1.7 V to 1.95 V supply, typically connect to output of internal DC/DC ⁽²⁾⁽³⁾
VDDR_RF	48	Power	1.7 V to 1.95 V supply, typically connect to output of internal DC/DC ⁽⁴⁾⁽³⁾
DCOUPPL	23	Power	1.27 V regulated digital-supply decoupling capacitor ⁽³⁾
EGP		Power	Ground – Exposed Ground Pad
DCDC_SW	33	Power	Output from internal DC/DC ⁽¹⁾
RESET_N	35	Digital input	Reset, active-low. No internal pullup
DIO_0	5	Digital I/O	GPIO, Sensor Controller

(1) See Section 8.2, technical reference manual for more details.

(2) If internal DC/DC is not used, this pin is supplied internally from the main LDO.

(3) Do not supply external circuitry from this pin.

(4) If internal DC/DC is not used, this pin must be connected to VDDR for supply from the main LDO.

Table 4-3. Signal Descriptions – RGZ Package (continued)

Pin Name	Pin	Pin Type	Description
DIO_1	6	Digital I/O	GPIO, Sensor Controller
DIO_2	7	Digital I/O	GPIO, Sensor Controller
DIO_3	8	Digital I/O	GPIO, Sensor Controller
DIO_4	9	Digital I/O	GPIO, Sensor Controller
DIO_5	10	Digital I/O	GPIO, Sensor Controller, High drive capability
DIO_6	11	Digital I/O	GPIO, Sensor Controller, High drive capability
DIO_7	12	Digital I/O	GPIO, Sensor Controller, High drive capability
DIO_8	14	Digital I/O	GPIO
DIO_9	15	Digital I/O	GPIO
DIO_10	16	Digital I/O	GPIO
DIO_11	17	Digital I/O	GPIO
DIO_12	18	Digital I/O	GPIO
DIO_13	19	Digital I/O	GPIO
DIO_14	20	Digital I/O	GPIO
DIO_15	21	Digital I/O	GPIO
DIO_16	26	Digital I/O	GPIO, JTAG_TDO, High drive capability
DIO_17	27	Digital I/O	GPIO, JTAG_TDI, High drive capability
DIO_18	28	Digital I/O	GPIO
DIO_19	29	Digital I/O	GPIO
DIO_20	30	Digital I/O	GPIO
DIO_21	31	Digital I/O	GPIO
DIO_22	32	Digital I/O	GPIO
DIO_23	36	Digital/Analog I/O	GPIO, Sensor Controller, Analog
DIO_24	37	Digital/Analog I/O	GPIO, Sensor Controller, Analog
DIO_25	38	Digital/Analog I/O	GPIO, Sensor Controller, Analog
DIO_26	39	Digital/Analog I/O	GPIO, Sensor Controller, Analog
DIO_27	40	Digital/Analog I/O	GPIO, Sensor Controller, Analog
DIO_28	41	Digital/Analog I/O	GPIO, Sensor Controller, Analog
DIO_29	42	Digital/Analog I/O	GPIO, Sensor Controller, Analog
DIO_30	43	Digital/Analog I/O	GPIO, Sensor Controller, Analog
JTAG_TMSC	24	Digital I/O	JTAG TMS, High drive capability
JTAG_TCKC	25	Digital I/O	JTAG TCKC
X32K_Q1	3	Analog I/O	32 kHz crystal oscillator pin 1
X32K_Q2	4	Analog I/O	32 kHz crystal oscillator pin 2
X24M_N	46	Analog I/O	24 MHz crystal oscillator pin 1
X24M_P	47	Analog I/O	24 MHz crystal oscillator pin 2

5 Specifications

5.1 Absolute Maximum Ratings⁽¹⁾⁽²⁾

[over operating free-air temperature range (unless otherwise noted)] Under no circumstances must the absolute maximum ratings be violated. Stress exceeding one or more of the limiting values may cause permanent damage to the device.

		MIN	MAX	UNIT
Supply voltage, VDD _S ⁽³⁾	VDDR supplied by internal DC/DC regulator or internal GLDO	-0.3	4.1	V
Supply voltage, VDD _S ⁽³⁾ and VDDR	External regulator mode (VDD _S and VDDR pins connected on PCB)	-0.3	2.25	V
Voltage on any digital pin ⁽⁴⁾		-0.3	VDD _S +0.3, max 4.1	V
Voltage on crystal oscillator pins, X32K_Q1, X32K_Q2, X24M_N and X24M_P		-0.3	VDDR+0.3, max 2.25	V
Voltage on ADC input (V _{in})	Internal fixed or relative reference, voltage scaling enabled	-0.3	VDD _S	V
	Internal fixed reference, voltage scaling disabled	-0.3	1.49	
	Internal relative reference, voltage scaling disabled	-0.3	VDD _S / 2.9	
	External reference, voltage scaling enabled	-0.3	min (V _{ref} × 2.9, VDD _S)	
	External reference, voltage scaling disabled	-0.3	V _{ref}	
Voltage on external ADC reference (V _{ref})		-0.3	1.6	V
Input RF level			+5	dBm
T _{stg}	Storage temperature	-40	150	°C

- (1) All voltage values are with respect to VDD_S, unless otherwise noted.
- (2) Stresses beyond those listed under Absolute Maximum Ratings may cause permanent damage to the device. These are stress ratings only, and functional operation of the device at these or any other conditions beyond those indicated under Recommended Operating Conditions is not implied. Exposure to absolute-maximum-rated conditions for extended periods may affect device reliability.
- (3) VDD_{S2} and VDD_{S3} needs to be at the same potential as VDD_S.
- (4) Including analog capable DIO.

5.2 ESD Ratings

			VALUE	UNIT	
V _{ESD}	Electrostatic discharge (ESD) performance:	Human Body Model (HBM), per ANSI/ESDA/JEDEC JS001 ⁽¹⁾	All pins	±2500	V
		Charged Device Model (CDM), per JESD22-C101 ⁽²⁾	RF pins	±750	
			non-RF pins	±750	

- (1) JEDEC document JEP155 states that 500-V HBM allows safe manufacturing with a standard ESD control process.
- (2) JEDEC document JEP157 states that 250-V CDM allows safe manufacturing with a standard ESD control process.

5.3 Recommended Operating Conditions

The operating conditions for CC2640 are listed below.

		MIN	MAX	UNIT
Ambient temperature range		-40	85	°C
Operating supply voltage (VDD _S and VDDR), external regulator mode	For operation in 1.8 V systems (VDD _S and VDDR pins connected on PCB, internal DC/DC cannot be used)	1.7	1.95	V
Operating supply voltage (VDD _S)	For operation in battery-powered and 3.3 V systems (internal DC/DC can be used to minimize power consumption)	1.8	3.8	V
Rising supply voltage slew rate		0	100	mV/us
Falling supply voltage slew rate		0	20	mV/us

Recommended Operating Conditions (continued)

The operating conditions for CC2640 are listed below.

		MIN	MAX	UNIT
Falling supply voltage slew rate, with low-power flash settings ⁽¹⁾			3	mV/us
Positive temperature gradient in standby ⁽²⁾	No limitation for negative temperature gradient, or outside standby mode		5	°C/s

- (1) For smaller coin cell batteries, with high worst-case end-of-life equivalent source resistance, a 22uF VDDS input capacitor (see [Figure 7-1](#)) should be used to ensure compliance with this slew rate.
- (2) Applications using RCOSC_LF as sleep timer must also consider the drift in frequency caused by a change in temperature. See [Section 5.13](#)

5.4 Thermal Characteristics

NAME	DESCRIPTION	RSM (°C/W) ⁽¹⁾	RHB (°C/W) ⁽¹⁾	RGZ (°C/W) ⁽¹⁾
Θ_{JA}	Junction-to-ambient thermal resistance	36.9	32.8	29.6
$\Theta_{Jc\text{top}}$	Junction-to-case (top) thermal resistance	30.3	24.0	15.7
Θ_{JB}	Junction-to-board thermal resistance	7.6	6.8	6.2
Ψ_{JT}	Junction-to-top characterization parameter	0.4	0.3	0.3
Ψ_{JB}	Junction-to-board characterization parameter	7.4	6.8	6.2
$\Theta_{Jc\text{bot}}$	Junction-to-case (bottom) thermal resistance	2.1	1.9	1.9

- (1) °C/W = degrees Celsius per watt.

5.5 Electrical Characteristics

Measured on Texas Instruments CC2650EM-5XD reference design with $T_c=25^\circ\text{C}$, $V_{\text{DD5}} = 3.0\text{ V}$ with internal DC-DC converter, unless otherwise noted.

PARAMETER		TEST CONDITIONS	MIN	TYP	MAX	UNIT	
I_{core}	Core current consumption	Reset. RESET_N pin asserted		100		nA	
		Shutdown. No clocks running, no retention		150			
		Standby. With RTC, CPU, RAM and (partial) register retention. RCOSC_LF			1		μA
		Standby. With RTC, CPU, RAM and (partial) register retention. XOSC_LF			1.2		
		Standby. With Cache, RTC, CPU, RAM and (partial) register retention. RCOSC_LF			2.5		
		Standby. With Cache, RTC, CPU, RAM and (partial) register retention. XOSC_LF			2.7		
		Idle. Supply Systems and RAM powered.			550		
		Active. Core running CoreMark			1.45 mA + 31 $\mu\text{A}/\text{MHz}$		mA
		Radio RX ⁽¹⁾			5.9		
		Radio RX ⁽²⁾			6.1		
		Radio TX, 0 dBm output power ⁽¹⁾			6.1		
		Radio TX, 5 dBm output power ⁽²⁾		9.1			
I_{peri}	Peripheral Current Consumption (Adds to core current I_{core} for each peripheral unit activated) ⁽³⁾						
	Peripheral power domain	Delta current with domain enabled		20		μA	
	Serial power domain	Delta current with domain enabled		13		μA	
	RF Core	Delta current with power domain enabled, clock enabled, RF Core Idle		237		μA	
	μDMA	Delta current with clock enabled, module idle		130		μA	
	Timers	Delta current with clock enabled, module idle		113		μA	
	I ² C	Delta current with clock enabled, module idle		12		μA	
	I2S	Delta current with clock enabled, module idle		36		μA	
	SSI	Delta current with clock enabled, module idle		93		μA	
	UART	Delta current with clock enabled, module idle		164		μA	

(1) Single-ended RF mode optimized for size and power consumption. Measured on CC2650EM-4XS

(2) Differential RF mode optimized for RF performance. Measured on CC2650EM-5XD

(3) I_{peri} not supported in Standby and Shutdown

5.6 General Characteristics

Measured on Texas Instruments CC2650EM-5XD reference design with $T_c=25^\circ\text{C}$, $V_{\text{DDS}} = 3.0\text{ V}$, unless otherwise noted.

PARAMETER	TEST CONDITIONS	MIN	TYP	MAX	UNIT
Wake-up and Timing					
Idle -> Active			14		μs
Standby -> Active			151		μs
Shutdown -> Active			1015		μs
Flash Memory					
Supported flash erase cycles before failure		100			k Cycles
Flash page/sector erase current	Average delta current		12.6		mA
Flash page/sector erase time ⁽¹⁾			8		ms
Flash page/sector size			4		KB
Flash write current	Average delta current, 4 bytes at a time		8.15		mA
Flash write time ⁽¹⁾	4 bytes at a time		8		μs

(1) This number is dependent on Flash aging and will increase over time and erase cycles

5.7 1-Mbps GFSK (Bluetooth Low Energy) – RX

Measured on Texas Instruments CC2650EM-5XD reference design with $T_c=25^\circ\text{C}$, $V_{\text{DDS}} = 3.0\text{ V}$, $f_{\text{RF}} = 2440\text{ MHz}$, unless otherwise noted.

PARAMETER	TEST CONDITIONS	MIN	TYP	MAX	UNIT
Receiver sensitivity	Differential mode. Measured at the CC2650EM-5XD SMA connector, BER = 10^{-3}		-97		dBm
Receiver sensitivity	Single-ended mode. Measured on CC2650EM-4XS, at the SMA connector, BER = 10^{-3}		-96		dBm
Receiver saturation	Differential mode. Measured at the CC2650EM-5XD SMA connector, BER = 10^{-3}		4		dBm
Receiver saturation	Single-ended mode. Measured on CC2650EM-4XS, at the SMA connector, BER = 10^{-3}		0		dBm
Co-channel rejection ⁽¹⁾	Wanted signal at -67 dBm, modulated interferer in channel, BER = 10^{-3}		-6		dB
Selectivity, $\pm 1\text{ MHz}$ ⁽¹⁾	Wanted signal at -67 dBm, modulated interferer at $\pm 1\text{ MHz}$, BER = 10^{-3}		7 / 3 ⁽²⁾		dB
Selectivity, $\pm 2\text{ MHz}$ ⁽¹⁾	Wanted signal at -67 dBm, modulated interferer at $\pm 2\text{ MHz}$, BER = 10^{-3}		34 / 25 ⁽²⁾		dB
Selectivity, $\pm 3\text{ MHz}$ ⁽¹⁾	Wanted signal at -67 dBm, modulated interferer at $\pm 3\text{ MHz}$, BER = 10^{-3}		38 / 26 ⁽²⁾		dB
Selectivity, $\pm 4\text{ MHz}$ ⁽¹⁾	Wanted signal at -67 dBm, modulated interferer at $\pm 4\text{ MHz}$, BER = 10^{-3}		42 / 29 ⁽²⁾		dB
Selectivity, $\pm 5\text{ MHz}$ or more ⁽¹⁾	Wanted signal at -67 dBm, modulated interferer at $\geq \pm 5\text{ MHz}$, BER = 10^{-3}		32		dB
Selectivity, Image frequency ⁽¹⁾	Wanted signal at -67 dBm, modulated interferer at image frequency, BER = 10^{-3}		25		dB
Selectivity, Image frequency $\pm 1\text{ MHz}$ ⁽¹⁾	Wanted signal at -67 dBm, modulated interferer at $\pm 1\text{ MHz}$ from image frequency, BER = 10^{-3}		3 / 26 ⁽²⁾		dB
Out-of-band blocking ⁽³⁾	30 MHz to 2000 MHz		-20		dBm
Out-of-band blocking	2003 MHz to 2399 MHz		-5		dBm
Out-of-band blocking	2484 MHz to 2997 MHz		-8		dBm
Out-of-band blocking	3000 MHz to 12.75 GHz		-8		dBm
Intermodulation	Wanted signal at 2402 MHz, -64 dBm. Two interferers at 2405 and 2408 MHz respectively, at the given power level		-34		dBm

(1) Numbers given as I/C dB

(2) X / Y, where X is +N MHz and Y is -N MHz

(3) Excluding one exception at $F_{\text{wanted}} / 2$, per Bluetooth Specification

1-Mbps GFSK (*Bluetooth Low Energy*) – RX (*continued*)

Measured on Texas Instruments CC2650EM-5XD reference design with $T_c=25^\circ\text{C}$, $V_{\text{DDS}} = 3.0\text{ V}$, $f_{\text{RF}} = 2440\text{ MHz}$, unless otherwise noted.

PARAMETER	TEST CONDITIONS	MIN	TYP	MAX	UNIT
Spurious emissions, 30 to 1000 MHz	Conducted measurement in a 50 Ω single-ended load. Suitable for systems targeting compliance with EN 300 328, EN 300 440 class 2, FCC CFR47, Part 15 and ARIB STD-T-66		-71		dBm
Spurious emissions, 1 to 12.75 GHz	Conducted measurement in a 50 Ω single-ended load. Suitable for systems targeting compliance with EN 300 328, EN 300 440 class 2, FCC CFR47, Part 15 and ARIB STD-T-66		-62		dBm
RSSI dynamic range			70		dB
RSSI accuracy			± 4		dB

5.8 1-Mbps GFSK (*Bluetooth Low Energy*) – TX

Measured on Texas Instruments CC2650EM-5XD reference design with $T_c=25^\circ\text{C}$, $V_{\text{DDS}} = 3.0\text{ V}$, $f_{\text{RF}} = 2440\text{ MHz}$, unless otherwise noted.

PARAMETER	TEST CONDITIONS	MIN	TYP	MAX	UNIT
Output power, highest setting	Differential mode, delivered to a single-ended 50- Ω load through a balun		+5		dBm
Output power, highest setting	Measured on CC2650EM-4XS, delivered to a single-ended 50- Ω load		+2		dBm
Output power, lowest setting	Delivered to a single-ended 50- Ω load through a balun		-21		dBm
Spurious emission conducted measurement	$f < 1\text{ GHz}$, outside restricted bands		-43		dBm
	$f < 1\text{ GHz}$, restricted bands ETSI		-65		dBm
	$f < 1\text{ GHz}$, restricted bands FCC		-76		dBm
	$f > 1\text{ GHz}$, including harmonics		-46		dBm
	Suitable for systems targeting compliance with worldwide radio-frequency regulations ETSI EN 300 328 and EN 300 440 Class 2 (Europe), FCC CFR47 Part 15 (US), and ARIB STD-T66 (Japan)				

5.9 1-Mbps GFSK (*Bluetooth Low Energy*) – Common RX/TX

Measured on Texas Instruments CC2650EM-5XD reference design with $T_c=25^\circ\text{C}$, $V_{\text{DDS}} = 3.0\text{ V}$, unless otherwise noted.

PARAMETER	TEST CONDITIONS	MIN	TYP	MAX	UNIT
Frequency error tolerance	Difference between center frequency of the received RF signal and local oscillator frequency.	-350	+350		kHz
Data rate error tolerance		-750	+750		ppm

5.10 24-MHz Crystal Oscillator (XOSC_HF)⁽¹⁾

Measured on Texas Instruments CC2650EM-5XD reference design with $T_c=25^\circ\text{C}$, $V_{\text{DDS}} = 3.0\text{ V}$, unless otherwise noted.

PARAMETER	TEST CONDITIONS	MIN	TYP	MAX	UNIT
Crystal frequency			24		MHz
Crystal frequency tolerance ⁽²⁾		-40		40	ppm
ESR Equivalent series resistance			20	60	Ω
CL Crystal load capacitance		5		9	pF
Start-up time ⁽³⁾			150		μs

- (1) Probing or otherwise stopping the XTAL while the DC-DC converter is enabled may cause permanent damage to the device.
 (2) Includes initial tolerance of the crystal, drift over temperature, aging and frequency pulling due to incorrect load capacitance. As per Bluetooth specification
 (3) Kick-started based on a temperature and aging compensated RCOSC_HF using precharge injection

5.11 32.768-kHz Crystal Oscillator (XOSC_LF)

Measured on Texas Instruments CC2650EM-5XD reference design with $T_c=25^\circ\text{C}$, $V_{\text{DDS}} = 3.0\text{ V}$, unless otherwise noted.

PARAMETER	TEST CONDITIONS	MIN	TYP	MAX	UNIT
Crystal frequency			32.768		kHz
Crystal frequency tolerance, Bluetooth low energy applications		-250		250	ppm
ESR Equivalent series resistance			30	100	k Ω
CL Crystal load capacitance		6		12	pF

5.12 48-MHz RC Oscillator (RCOSC_HF)

Measured on Texas Instruments CC2650EM-5XD reference design with $T_c=25^\circ\text{C}$, $V_{\text{DDS}} = 3.0\text{ V}$, unless otherwise noted.

PARAMETER	TEST CONDITIONS	MIN	TYP	MAX	UNIT
Frequency			48		MHz
Uncalibrated frequency accuracy			$\pm 1\%$		
Calibrated frequency accuracy ⁽¹⁾			$\pm 0.25\%$		
Start-up time			5		μs

- (1) Accuracy relatively to the calibration source (XOSC_HF).

5.13 32-kHz RC Oscillator (RCOSC_LF)

Measured on Texas Instruments CC2650EM-5XD reference design with $T_c=25^\circ\text{C}$, $V_{\text{DDS}} = 3.0\text{ V}$, unless otherwise noted.

PARAMETER	TEST CONDITIONS	MIN	TYP	MAX	UNIT
Calibrated frequency			32.8		kHz
Temperature coefficient			50		ppm/ $^\circ\text{C}$

5.14 ADC Characteristics⁽¹⁾

$T_c=25^\circ\text{C}$, $V_{\text{DDS}} = 3.0\text{ V}$ and voltage scaling enabled, unless otherwise noted.

PARAMETER		TEST CONDITIONS	MIN	TYP	MAX	UNIT
	Input voltage range		0		V_{DDS}	V
	Resolution			12		Bits
	Sample rate				200	ksps
	Offset	Internal 4.3 V equivalent reference ⁽²⁾		2		LSB
	Gain error	Internal 4.3 V equivalent reference ⁽²⁾		2.4		LSB
DNL ⁽³⁾	Differential nonlinearity			>-1		LSB
INL ⁽⁴⁾	Integral nonlinearity			±3		LSB
ENOB	Effective number of bits	Internal 4.3 V equivalent reference ⁽²⁾ , 200 ksps, 9.6 kHz input tone		9.8		Bits
		V_{DDS} as reference, 200 ksps, 9.6 kHz input tone		10		
		Internal 1.44 V reference, voltage scaling disabled, 32 samples average, 200 ksps, 300 Hz input tone		11.1		
THD	Total harmonic distortion	Internal 4.3 V equivalent reference ⁽²⁾ , 200 ksps, 9.6 kHz input tone		-65		dB
		V_{DDS} as reference, 200 ksps, 9.6 kHz input tone		-69		
		Internal 1.44 V reference, voltage scaling disabled, 32 samples average, 200 ksps, 300 Hz input tone		-71		
SINAD / SNDR	Signal-to-noise and distortion ratio	Internal 4.3 V equivalent reference ⁽²⁾ , 200 ksps, 9.6 kHz input tone		60		dB
		V_{DDS} as reference, 200 ksps, 9.6 kHz input tone		63		
		Internal 1.44 V reference, voltage scaling disabled, 32 samples average, 200 ksps, 300 Hz input tone		69		
SFDR	Spurious-free dynamic range	Internal 4.3 V equivalent reference ⁽²⁾ , 200 ksps, 9.6 kHz input tone		67		dB
		V_{DDS} as reference, 200 ksps, 9.6 kHz input tone		72		
		Internal 1.44 V reference, voltage scaling disabled, 32 samples average, 200 ksps, 300 Hz input tone		73		
	Conversion time	Serial conversion, time-to-output, 24 MHz clock		50		clock-cycles
	Current consumption	Internal 4.3 V equivalent reference ⁽²⁾		0.66		mA
	Current consumption	V_{DDS} as reference		0.75		mA
	Internal reference voltage	Internal 4.3 V equivalent reference ⁽²⁾		1.44		V
	Internal reference voltage	V_{DDS} as reference		$V_{\text{DDS}} / 2.82$		V

(1) Using IEEE Std 1241™-2010 for terminology and test methods.

(2) Input signal scaled down internally before conversion, as if voltage range was 0 to 4.3V

(3) No missing codes. Positive DNL typically varies from +0.3 to +3.5 depending on device, see [Figure 5-13](#)

(4) For a typical example, see [Figure 5-14](#)

5.15 Temperature Sensor

Measured on Texas Instruments CC2650EM-5XD reference design with $T_c=25^\circ\text{C}$, $V_{\text{DDS}} = 3.0\text{ V}$, unless otherwise noted.

PARAMETER	TEST CONDITIONS	MIN	TYP	MAX	UNIT
Resolution			4		°C
Range		-40		85	°C
Accuracy			±5		°C
Supply voltage coefficient ⁽¹⁾			3.2		°C/V

(1) Automatically compensated when using supplied driver libraries.

5.16 Battery Monitor

Measured on Texas Instruments CC2650EM-5XD reference design with $T_c=25^\circ\text{C}$, $V_{\text{DDS}} = 3.0\text{ V}$, unless otherwise noted.

PARAMETER	TEST CONDITIONS	MIN	TYP	MAX	UNIT
Resolution			50		mV
Range		1.8		3.8	V

Battery Monitor (continued)

Measured on Texas Instruments CC2650EM-5XD reference design with $T_c=25^\circ\text{C}$, $V_{\text{DDS}} = 3.0\text{ V}$, unless otherwise noted.

PARAMETER	TEST CONDITIONS	MIN	TYP	MAX	UNIT
Accuracy			13		mV

5.17 Continuous Time Comparator

$T_c=25^\circ\text{C}$, $V_{\text{DDS}} = 3.0\text{ V}$, unless otherwise noted.

PARAMETER	TEST CONDITIONS	MIN	TYP	MAX	UNIT
Input voltage range		0		V_{DDS}	V
External reference voltage		0		V_{DDS}	V
Internal reference voltage	DCOUPPL as reference		1.27		V
Offset			3		mV
Hysteresis			<2		mV
Decision time	Step from -10mV to +10mV		0.72		μs
Current consumption when enabled ⁽¹⁾			8.6		μA

(1) Additionally the bias module needs to be enabled when running in standby mode.

5.18 Low-Power Clocked Comparator

$T_c=25^\circ\text{C}$, $V_{\text{DDS}} = 3.0\text{ V}$, unless otherwise noted.

PARAMETER	TEST CONDITIONS	MIN	TYP	MAX	UNIT
Input voltage range		0		V_{DDS}	V
Clock frequency			32		kHz
Internal reference voltage, $V_{\text{DDS}} / 2$			1.49 - 1.51		V
Internal reference voltage, $V_{\text{DDS}} / 3$			1.01 - 1.03		V
Internal reference voltage, $V_{\text{DDS}} / 4$			0.78 - 0.79		V
Internal reference voltage, $\text{DCOUPPL} / 1$			1.25 - 1.28		V
Internal reference voltage, $\text{DCOUPPL} / 2$			0.63 - 0.65		V
Internal reference voltage, $\text{DCOUPPL} / 3$			0.42 - 0.44		V
Internal reference voltage, $\text{DCOUPPL} / 4$			0.33 - 0.34		V
Offset			<2		mV
Hysteresis			<5		mV
Decision time	Step from -50mV to +50mV		<1		clock-cycle
Current consumption when enabled			362		nA

5.19 Programmable Current Source

$T_c=25^\circ\text{C}$, $V_{\text{DDS}} = 3.0\text{ V}$, unless otherwise noted.

PARAMETER	TEST CONDITIONS	MIN	TYP	MAX	UNIT
Current source programmable output range			0.25 - 20		μA
Resolution			0.25		μA
Current consumption ⁽¹⁾	Including current source at maximum programmable output		23		μA

(1) Additionally the bias module needs to be enabled when running in standby mode.

5.20 DC Characteristics

PARAMETER	TEST CONDITIONS	MIN	TYP	MAX	UNIT
$T_A = 25^\circ\text{C}$, $V_{\text{DDS}} = 1.8\text{ V}$					
GPIO VOH at 8mA load	IOCURR=2, high drive GPIOs only		1.54		V
GPIO VOL at 8mA load	IOCURR=2, high drive GPIOs only		0.26		V
GPIO VOH at 4mA load	IOCURR=1		1.58		V
GPIO VOL at 4mA load	IOCURR=1		0.21		V
GPIO pullup current	Input mode, pullup enabled, $V_{\text{pad}}=0\text{V}$		71.7		μA
GPIO pulldown current	Input mode, pulldown enabled, $V_{\text{pad}}=V_{\text{DDS}}$		21.1		μA
GPIO high/low input transition, no hysteresis	IH=0, transition between reading 0 and reading 1		0.88		V
GPIO low-to-high input transition, with hysteresis	IH=1, transition voltage for input read as 0→1		1.07		V
GPIO high-to-low input transition, with hysteresis	IH=1, transition voltage for input read as 1→0		0.74		V
GPIO input hysteresis	IH=1, difference between 0→1 and 1→0 points		0.33		V
$T_A = 25^\circ\text{C}$, $V_{\text{DDS}} = 3.0\text{ V}$					
GPIO VOH at 8mA load	IOCURR=2, high drive GPIOs only		2.68		V
GPIO VOL at 8mA load	IOCURR=2, high drive GPIOs only		0.33		V
GPIO VOH at 4mA load	IOCURR=1		2.72		V
GPIO VOL at 4mA load	IOCURR=1		0.28		V
$T_A = 25^\circ\text{C}$, $V_{\text{DDS}} = 3.8\text{ V}$					
GPIO pullup current	Input mode, pullup enabled, $V_{\text{pad}}=0\text{V}$		277		μA
GPIO pulldown current	Input mode, pulldown enabled, $V_{\text{pad}}=V_{\text{DDS}}$		113		μA
GPIO high/low input transition, no hysteresis	IH=0, transition between reading 0 and reading 1		1.67		V
GPIO low-to-high input transition, with hysteresis	IH=1, transition voltage for input read as 0→1		1.94		V
GPIO high-to-low input transition, with hysteresis	IH=1, transition voltage for input read as 1→0		1.54		V
GPIO input hysteresis	IH=1, difference between 0→1 and 1→0 points		0.4		V

5.21 Control Input AC Characteristics

$T_A = -40^\circ\text{C}$ to 85°C , $V_{\text{DDS}} = 1.7\text{ V}$ to 3.8 V , unless otherwise noted.

PARAMETER	TEST CONDITIONS	MIN	TYP	MAX	UNIT
RESET_N low duration		1			μs

5.22 Synchronous Serial Interface (SSI) Characteristics

$T_c=25^\circ\text{C}$, $V_{\text{DDS}} = 3.0\text{ V}$, unless otherwise noted.

PARAMETER NO.	PARAMETER	PARAMETER NAME	MIN	TYP	MAX	UNIT
S1	$t_{\text{clk_per}}$	SSIClk cycle time	12		65024	system clocks

5.23 Typical Characteristics

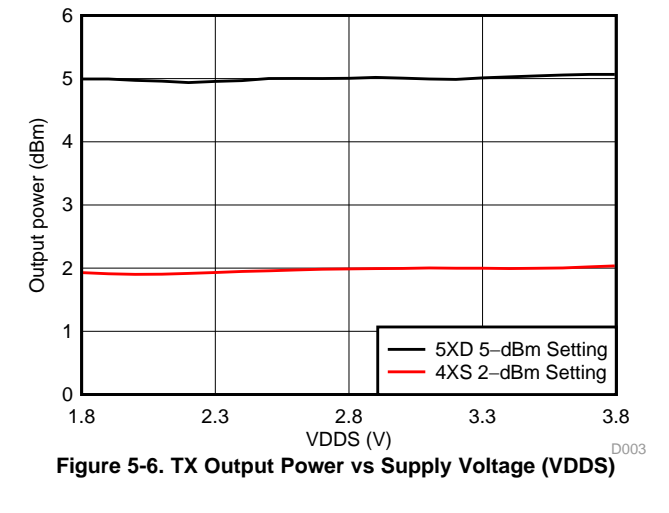
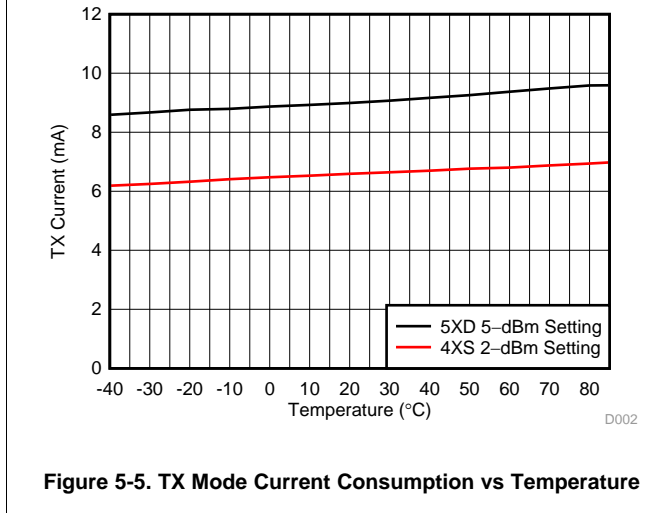
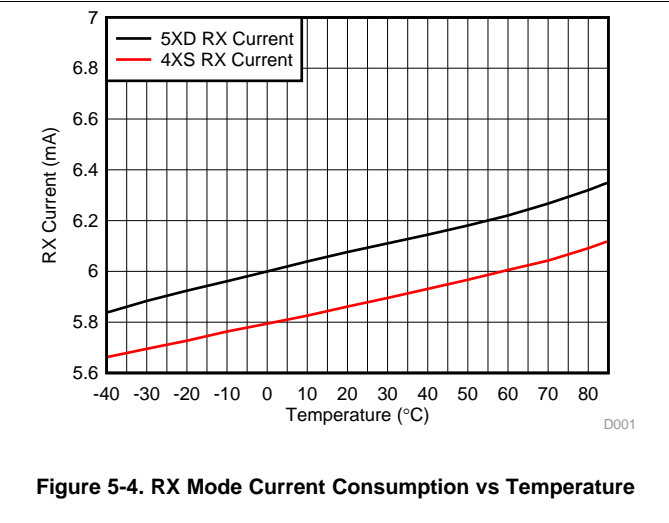
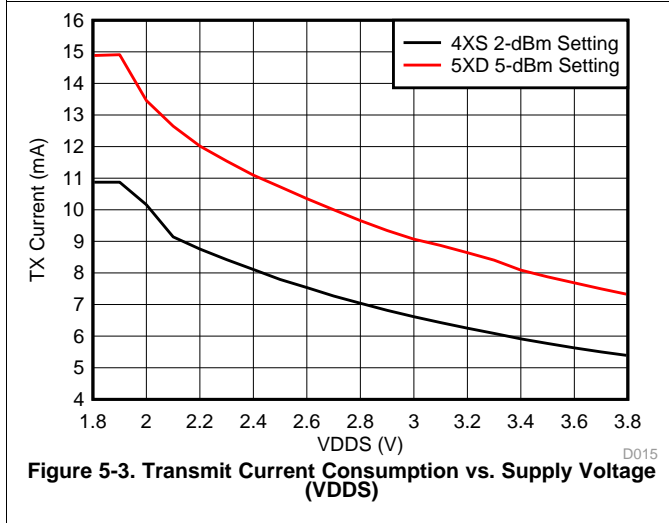
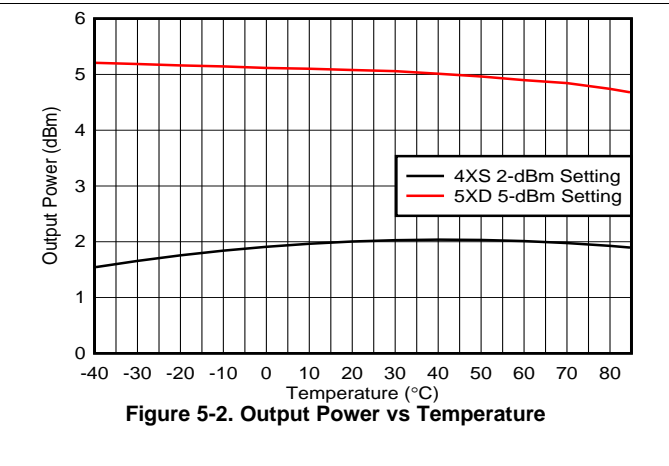
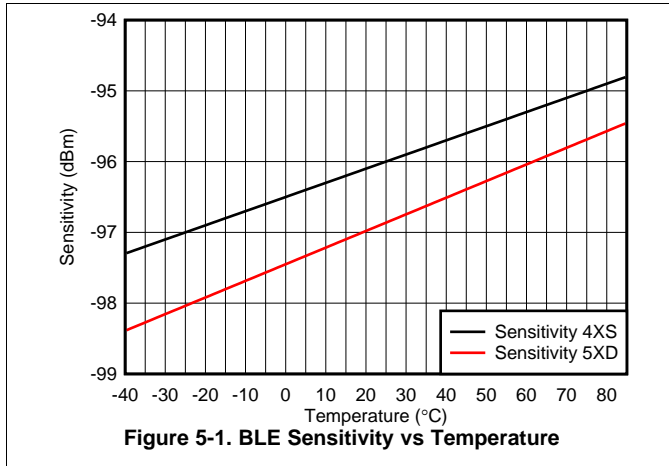

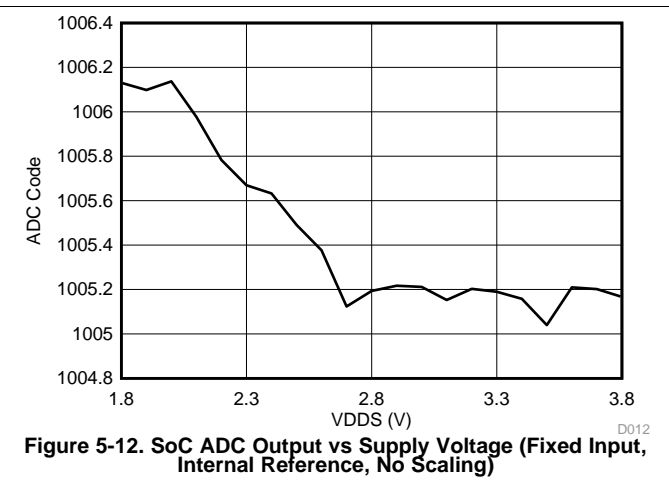
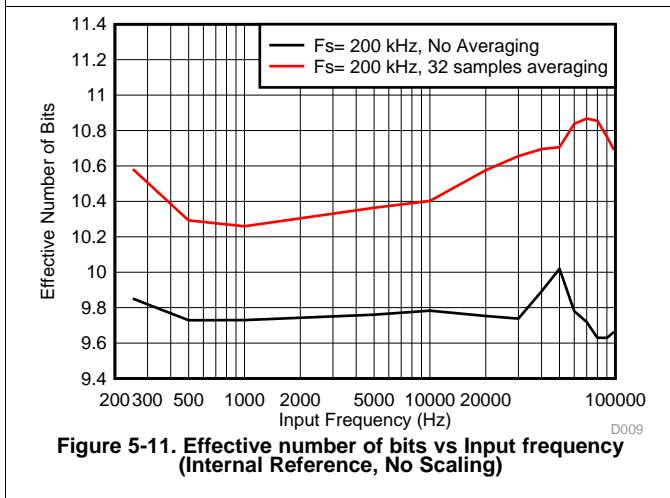
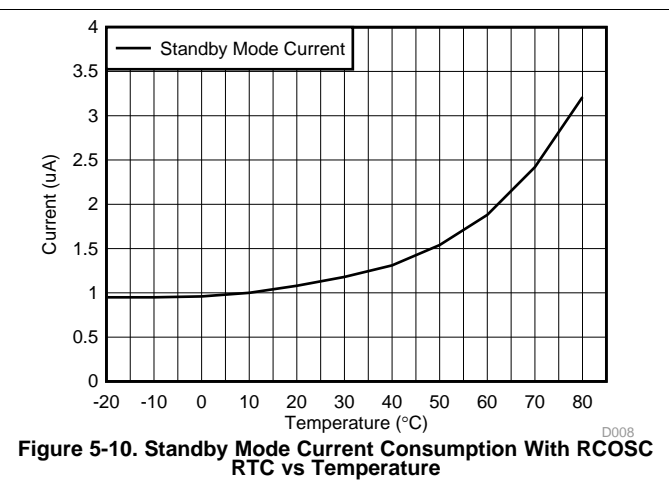
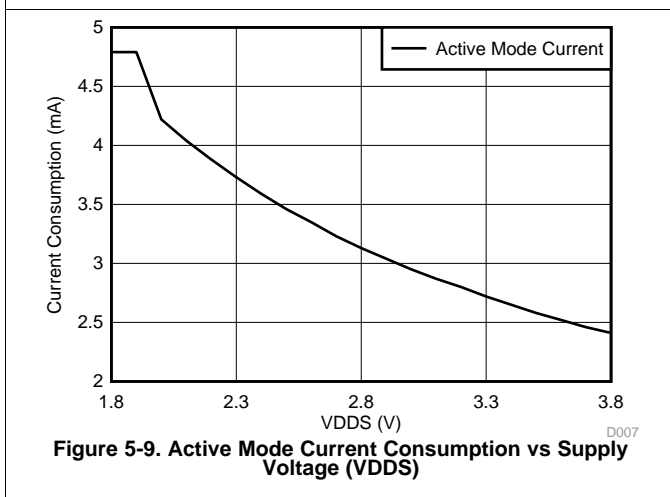
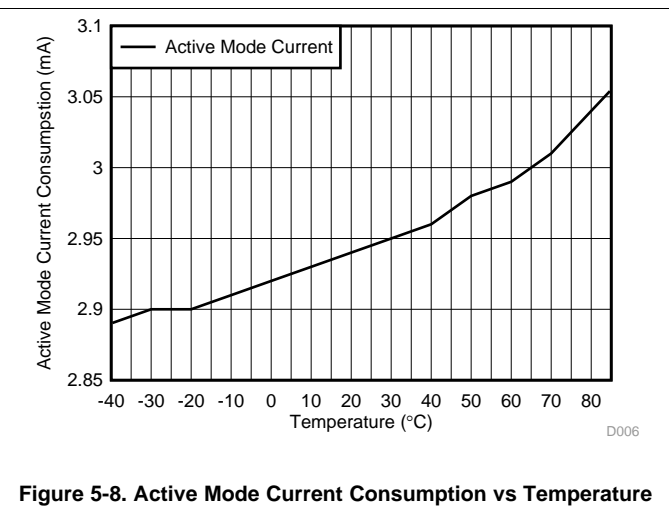
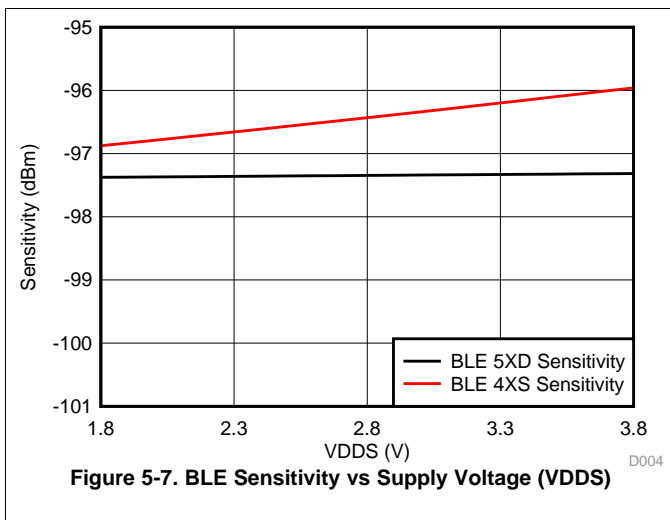

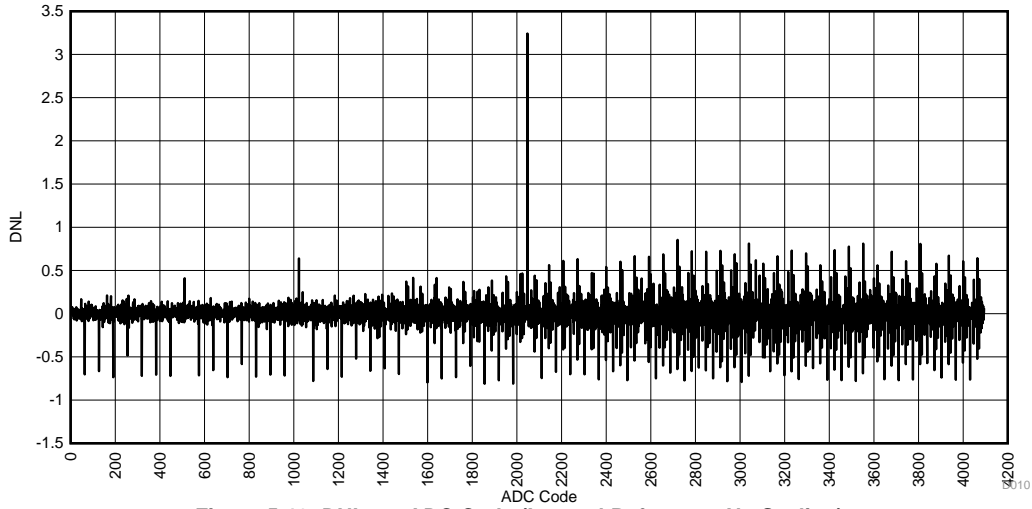

Figure 5-13. DNL vs. ADC Code (Internal Reference, No Scaling)

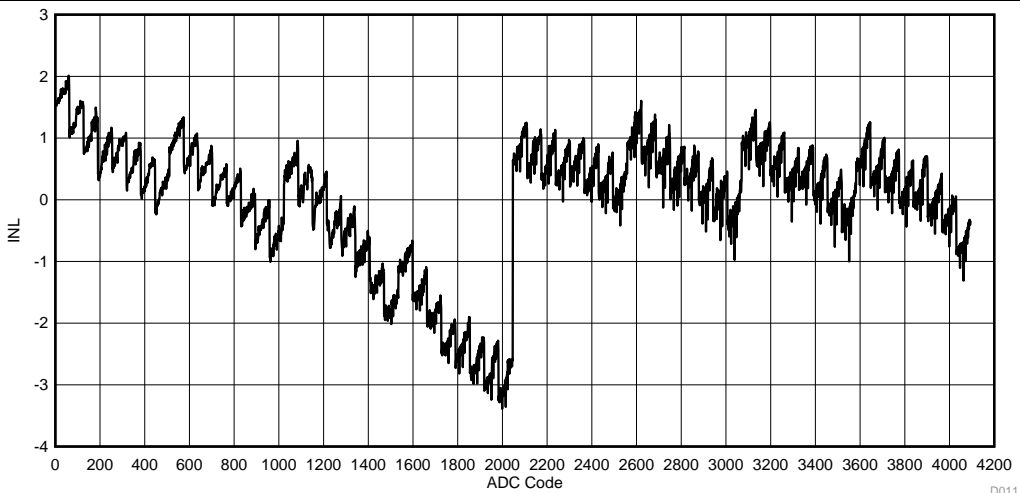

Figure 5-14. INL vs. ADC Code (Internal Reference, No Scaling)

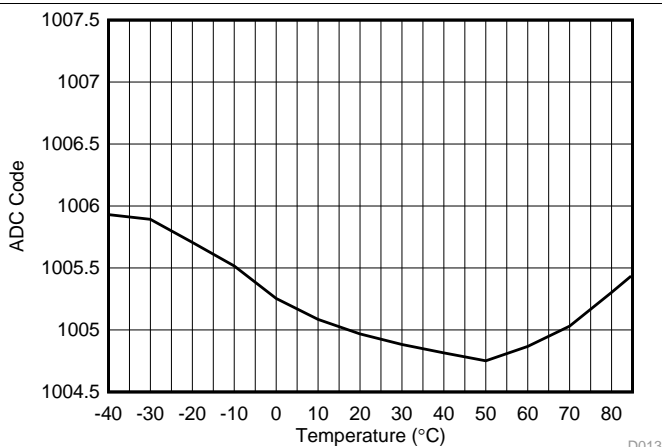

Figure 5-15. SoC ADC Output vs Temperature (Fixed Input, Internal Reference, No Scaling)

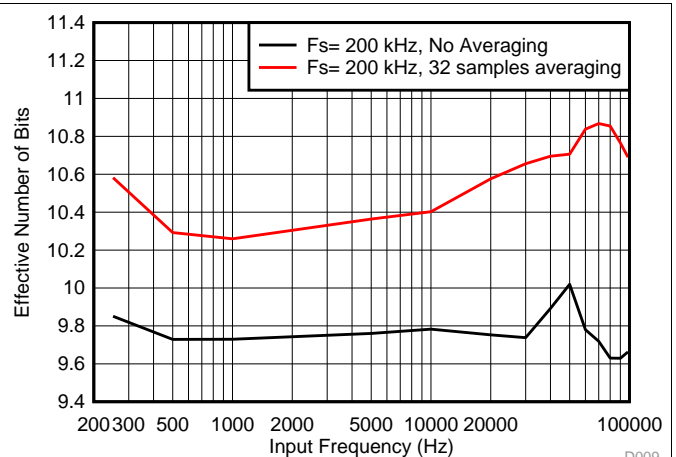

Figure 5-16. ENOB vs Sampling Frequency (Input frequency = $F_s/10$)

6 Detailed Description

6.1 Overview

[Section 1.4](#) shows a block diagram of the core modules of the CC26xx product family.

6.2 Main CPU

The SimpleLink CC2640 Wireless MCU contains an ARM Cortex-M3 (CM3) 32-bit CPU, which runs the application and the higher layers of the protocol stack.

The CM3 processor provides a high-performance, low-cost platform that meets the system requirements of minimal memory implementation, and low-power consumption, while delivering outstanding computational performance and exceptional system response to interrupts.

CM3 features include:

- 32-bit ARM Cortex-M3 architecture optimized for small-footprint embedded applications
- Outstanding processing performance combined with fast interrupt handling
- ARM Thumb[®]-2 mixed 16- and 32 bit instruction set delivers the high performance expected of a 32 bit ARM core in a compact memory size usually associated with 8- and 16-bit devices, typically in the range of a few kilobytes of memory for microcontroller-class applications:
 - Single-cycle multiply instruction and hardware divide
 - Atomic bit manipulation (bit-banding), delivering maximum memory use and streamlined peripheral control
 - Unaligned data access, enabling data to be efficiently packed into memory
- Fast code execution permits slower processor clock or increases sleep mode time
- Harvard architecture characterized by separate buses for instruction and data
- Efficient processor core, system, and memories
- Hardware division and fast digital-signal-processing oriented multiply accumulate
- Saturating arithmetic for signal processing
- Deterministic, high-performance interrupt handling for time-critical applications
- Enhanced system debug with extensive breakpoint and trace capabilities
- Serial wire trace reduces the number of pins required for debugging and tracing
- Migration from the ARM7[™] processor family for better performance and power efficiency
- Optimized for single-cycle flash memory use
- Ultra-low power consumption with integrated sleep modes
- 1.25 DMIPS per MHz

6.3 RF Core

The RF Core contains an ARM Cortex M0 that interfaces the analog RF and base-band circuitries, handles data to and from the system side, and assembles the information bits in a given packet structure. The RF core offers a high level, command-based API to the main CPU.

The RF core is capable of autonomously handling the time-critical aspects of the radio protocols (*Bluetooth* Low Energy) thus offloading the main CPU and leaving more resources for the user application.

The RF core has a dedicated 4-KB SRAM block and runs initially from separate ROM memory. The ARM Cortex M0 is not programmable by customers.

6.4 Sensor Controller

The Sensor Controller contains circuitry that can be selectively enabled in standby mode. The peripherals in this domain may be controlled by the Sensor Controller Engine which is a proprietary power-optimized CPU. This CPU can read and monitor sensors or perform other tasks autonomously, thereby significantly reducing power consumption and offloading the main CM3 CPU.

The Sensor Controller is set up using a PC-based configuration tool, called Sensor Controller Studio, and typical use cases may be (but are not limited to):

- Analog sensors using integrated ADC
- Digital sensors using GPIOs and bit-banged I²C and/or SPI
- UART communication for sensor reading or debugging
- Capacitive sensing
- Waveform generation
- Pulse counting
- Keyboard scan
- Quadrature decoder for polling rotation sensors
- Oscillator calibration

The peripherals in the Sensor Controller include the following:

- The low-power clocked comparator can be used to wake the device from any state in which the comparator is active. A configurable internal reference can be used in conjunction with the comparator. The output of the comparator can also be used to trigger an interrupt or the ADC.
- Capacitive sensing functionality is implemented through the use of a constant current source, a time-to-digital converter, and a comparator. The continuous time comparator in this block can also be used as a higher-accuracy alternative to the low-power clocked comparator. The Sensor Controller will take care of baseline tracking, hysteresis, filtering and other related functions.
- The ADC is a 12-bit, 200 ksamples/s ADC with 8 inputs and a built-in voltage reference. The ADC can be triggered by many different sources, including timers, I/O pins, software, the analog comparator, and the RTC.
- The Sensor Controller also includes a SPI/I²C digital interface.
- The analog modules can be connected to up to 8 different GPIOs.

The peripherals in the Sensor Controller can also be controlled from the main application processor.

Table 6-1. GPIOs Connected to the Sensor Controller⁽¹⁾

Analog capable	7x7 RGZ DIO#	5x5 RHB DIO#	4x4 RSM DIO#
Y	30	14	
Y	29	13	
Y	28	12	
Y	27	11	9
Y	26	9	8
Y	25	10	7
Y	24	8	6
Y	23	7	5
N	7	4	2
N	6	3	1
N	5	2	0
N	4	1	
N	3	0	
N	2		
N	1		
N	0		

(1) Depending on the package size, up to 16 pins can be connected to the Sensor Controller. Up to 8 of them can be connected to analog modules

6.5 Memory

The flash memory provides nonvolatile storage for code and data. The flash memory is in-system programmable.

The SRAM (static RAM) can be used for both storage of data and execution of code and is split into two 4-KB blocks and two 6-KB blocks. Retention of the RAM contents in standby mode can be enabled or disabled individually for each block to minimize power consumption. In addition, if flash cache is disabled, the 8-KB cache can be used as a general-purpose RAM.

The ROM provides preprogrammed embedded TI RTOS kernel, Driverlib and lower layer protocol stack software (*Bluetooth* Low Energy Controller). It also contains a bootloader that can be used to reprogram the device using SPI or UART.

6.6 Debug

The on-chip debug support is done through a dedicated cJTAG (IEEE 1149.7) or JTAG (IEEE 1149.1) interface.

6.7 Power Management

To minimize power consumption, the CC2640 supports a number of power modes and power management features (see [Table 6-2](#)).

Table 6-2. Power Modes

Mode	Software Configurable Power Modes				Reset Pin Held
	Active	Idle	Standby	Shutdown	
CPU	Active	Off	Off	Off	Off
Flash	On	Available	Off	Off	Off
SRAM	On	On	On	Off	Off
Radio	Available	Available	Off	Off	Off
Supply System	On	On	Duty Cycled	Off	Off
Current	1.45 mA + 31 µA/MHz	550 µA	1 µA	0.15 µA	0.1 µA
Wake-up Time to CPU Active ⁽¹⁾	–	14 µs	151 µs	1015 µs	1015 µs
Register Retention	Full	Full	Partial	No	No
SRAM Retention	Full	Full	Full	No	No
High-Speed Clock	XOSC_HF or RCOSC_HF	XOSC_HF or RCOSC_HF	Off	Off	Off
Low-Speed Clock	XOSC_LF or RCOSC_LF	XOSC_LF or RCOSC_LF	XOSC_LF or RCOSC_LF	Off	Off
Peripherals	Available	Available	Off	Off	Off
Sensor Controller	Available	Available	Available	Off	Off
Wake-up on RTC	Available	Available	Available	Off	Off
Wake-up on Pin Edge	Available	Available	Available	Available	Off
Wake-up on Reset Pin	Available	Available	Available	Available	Available

(1) Not including RTOS overhead

In Active mode, the application CM3 CPU is actively executing code. Active mode provides normal operation of the processor and all of the peripherals that are currently enabled. The system clock can be any available clock source (see [Table 6-2](#)).

In Idle mode, all active peripherals can be clocked, but the Application CPU core and memory are not clocked and no code is executed. Any interrupt event will bring the processor back into Active mode.

In Standby, only the AON (Always-on) domain is active. An external wake event, RTC event, or Sensor Controller event is required to bring the device back to Active. MCU peripherals with retention do not need to be reconfigured when waking up again and the CPU will continue execution from where it went into Standby. All GPIOs are latched in Standby.

In Shutdown, the device is entirely turned off, including the AON domain and Sensor Controller, I/Os are latched with the value they had before entering Shutdown. A change of state on any I/O pin defined as a "wake from Shutdown pin" will wake up the device and function as a reset trigger. The CPU can differentiate between reset in this way and reset-by-reset pin or power-on-reset by reading the reset status register. The only state retained in this mode is the latched I/O state and the Flash memory contents.

The Sensor Controller is an autonomous processor that can control the peripherals in the Sensor Controller independently of the main CPU. This means that the main CPU does not have to wake up to for example execute an ADC sample or poll a digital sensor over SPI, and saves both current and wake-up time that would otherwise be wasted. The Sensor Controller Studio enables the user to configure the Sensor Controller and choose which peripherals are controlled and which conditions will wake up the main CPU.

6.8 Clock Systems

The CC2640 supports two external and two internal clock sources.

A 24 MHz crystal is required as the frequency reference for the radio. This signal is doubled internally to create a 48 MHz clock.

The 32 kHz crystal is optional. *Bluetooth* low energy requires a slow-speed clock with better than ± 500 ppm accuracy if the device is to enter any sleep mode while maintaining a connection. The internal 32 kHz RC oscillator can in some use cases be compensated to meet the requirements. The low-speed crystal oscillator is designed for use with a 32 kHz watch-type crystal.

The internal high-speed oscillator (48 MHz) can be used as a clock source for the CPU subsystem.

The internal low-speed oscillator (32.768 kHz) can be used as a reference if the low-power crystal oscillator is not used.

The 32 kHz clock source can be used as external clocking reference through GPIO.

6.9 General Peripherals and Modules

The I/O controller controls the digital I/O pins and contains multiplexer circuitry to allow a set of peripherals to be assigned to I/O pins in a flexible manner. All digital I/Os are interrupt and wake-up capable, have a programmable pullup and pulldown function and can generate an interrupt on a negative or positive edge (configurable). When configured as an output, pins can function as either push-pull or open-drain. Five GPIOs have high drive capabilities (marked in **bold** in [Section 4](#)).

The SSIs are synchronous serial interfaces that are compatible with SPI, MICROWIRE, and Texas Instruments synchronous serial interfaces. The SSIs support both SPI master and slave up to 4 MHz.

The UART implements a universal asynchronous receiver/transmitter function. It supports flexible baud-rate generation up to a maximum of 3 Mbps and is compatible with the *Bluetooth* HCI specifications.

Timer 0 is a general-purpose timer module (GPTM), which provides two 16-bit timers. The GPTM can be configured to operate as a single 32-bit timer, dual 16-bit timers or as a PWM module.

Timer 1, Timer 2, and Timer 3 are also GPTMs. Each of these timers is functionally equivalent to Timer 0.

In addition to these four timers, the RF core has its own timer to handle timing for RF protocols; the RF timer can be synchronized to the RTC.

The I²C interface is used to communicate with devices compatible with the I²C standard. The I²C interface is capable of 100 kHz and 400 kHz operation, and can serve as both I²C master and I²C slave.

The TRNG module provides a true, nondeterministic noise source for the purpose of generating keys, initialization vectors (IVs), and other random number requirements. The TRNG is built on 24 ring oscillators that create unpredictable output to feed a complex nonlinear combinatorial circuit.

The watchdog timer is used to regain control if the system fails due to a software error after an external device fails to respond as expected. The watchdog timer can generate an interrupt or a reset when a predefined time-out value is reached.

The device includes a direct memory access (μ DMA) controller. The μ DMA controller provides a way to offload data transfer tasks from the CM3 CPU, allowing for more efficient use of the processor and the available bus bandwidth. The μ DMA controller can perform transfer between memory and peripherals. The μ DMA controller has dedicated channels for each supported on-chip module and can be programmed to automatically perform transfers between peripherals and memory as the peripheral is ready to transfer more data. Some features of the μ DMA controller include the following (this is not an exhaustive list):

- Highly flexible and configurable channel operation of up to 32 channels
- Transfer modes: Memory-to-memory, memory-to-peripheral, peripheral-to-memory, and peripheral-to-peripheral
- Data sizes of 8, 16, and 32 bits

The AON domain contains circuitry that is always enabled, except for in Shutdown (where the digital supply is off). This circuitry includes the following:

- The RTC can be used to wake the device from any state where it is active. The RTC contains three compare and one capture registers. With software support, the RTC can be used for clock and calendar operation. The RTC is clocked from the 32 kHz RC oscillator or crystal. The RTC can also be compensated to tick at the correct frequency even when the internal 32 kHz RC oscillator is used instead of a crystal.
- The battery monitor and temperature sensor are accessible by software and give a battery status indication as well as a coarse temperature measure.

6.10 System Architecture

Depending on the product configuration, CC26xx can function either as a Wireless Network Processor (WNP – an IC running the wireless protocol stack, with the application running on a separate MCU), or as a System-on-Chip (SoC), with the application and protocol stack running on the ARM CM3 core inside the device.

In the first case, the external host MCU communicates with the device using SPI or UART. In the second case, the application must be written according to the application framework supplied with the wireless protocol stack.

7 Application Circuit

NOTE

Information in the following applications sections is not part of the TI component specification, and TI does not warrant its accuracy or completeness. TI's customers are responsible for determining suitability of components for their purposes. Customers should validate and test their design implementation to confirm system functionality.

Few external components are required for the operation of the CC2640 device. [Figure 7-1](#) shows a typical application circuit. For a complete reference design, see the product folder on [www.ti.com](#).

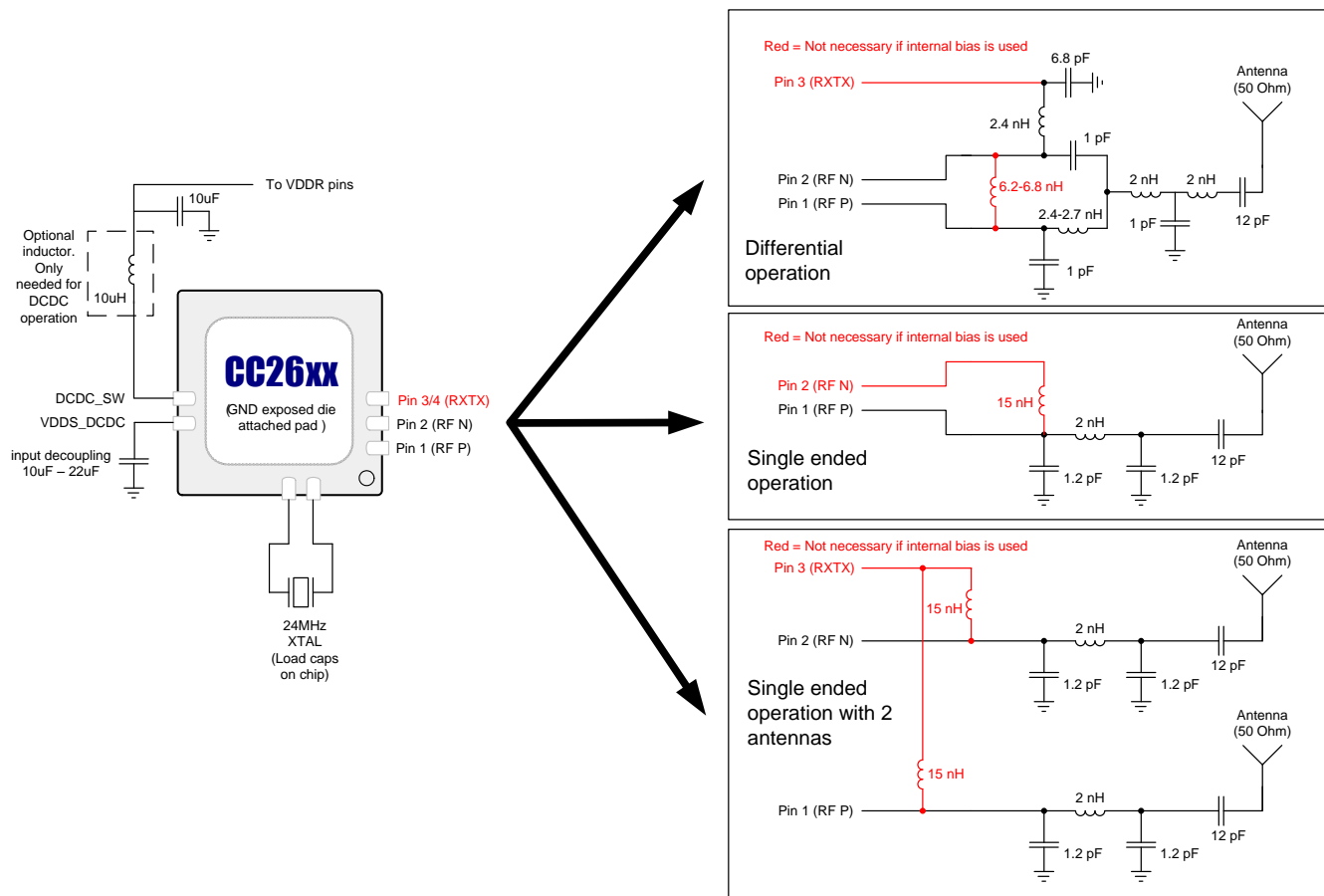

Figure 7-1. CC2640 Application Circuit

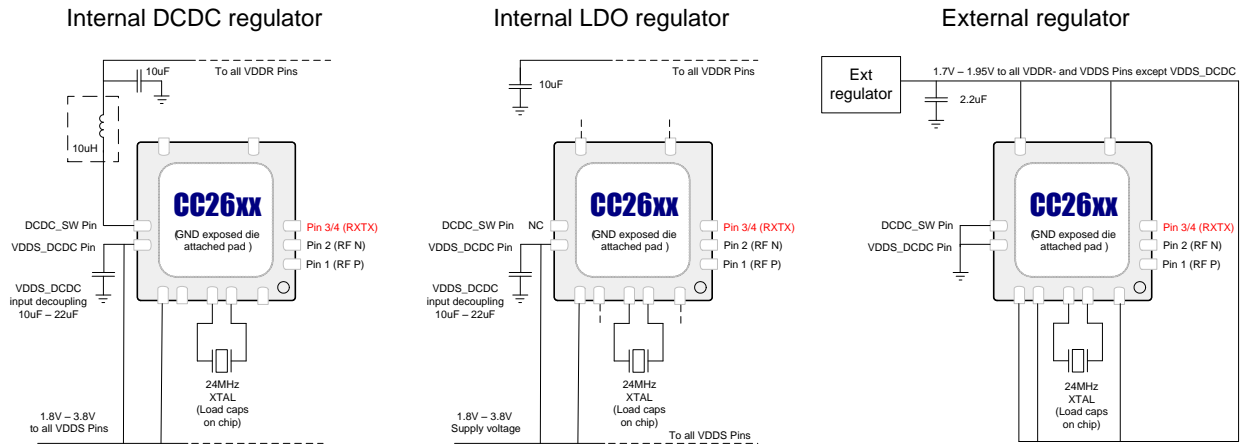

Figure 7-2. Supply Voltage Configurations

Power supply decoupling capacitors are not shown. Digital I/Os not included. Pin positions, and component values are not final. For detailed overview of power supply decoupling and wiring, see the TI reference designs and the CC26xx technical reference manual (Section 8.2).

Figure 7-1 shows that the RF front end can be used both differentially and single-endedly with the option of having internal or external biasing. These options allow for various trade-offs between cost, board-space, and RF performance. Differential operation with external bias gives the best performance while single-ended operation with internal bias gives the least amount of external components and the lowest power consumption.

8 Device and Documentation Support

8.1 Device Support

8.1.1 Development Support

TI offers an extensive line of development tools, including tools to evaluate the performance of the processors, generate code, develop algorithm implementations, and fully integrate and debug software and hardware modules.

The following products support development of the CC2640 device applications:

Software Tools:

SmartRF™ Studio 7:

SmartRF Studio is a PC application that helps designers of radio systems to easily evaluate the RF-IC at an early stage in the design process.

- Test functions for sending and receiving radio packets, continuous wave transmit and receive
- Evaluate RF performance on custom boards by wiring it to a supported evaluation board or debugger
- Can also be used without any hardware, but then only to generate, edit and export radio configuration settings
- Can be used in combination with several development kits for Texas Instruments' CCxxxx RF-ICs

Sensor Controller Studio:

Sensor Controller Studio provides a development environment for the CC26xx Sensor Controller. The Sensor Controller is a proprietary, power-optimized CPU in the CC26xx, which can perform simple background tasks autonomously and independent of the System CPU state.

- Allows for Sensor Controller task algorithms to be implemented using a C-like programming language
- Outputs a Sensor Controller Interface driver, which incorporates the generated Sensor Controller machine code and associated definitions
- Allows for rapid development by using the integrated Sensor Controller task testing and debugging functionality. This allows for live visualization of sensor data and algorithm verification.

IDEs and Compilers:

Code Composer Studio:

- Integrated development environment with project management tools and editor
- Code Composer Studio (CCS) 6.1 and later has built-in support for the CC26xx device family
- Best support for XDS debuggers; XDS100v3, XDS110 and XDS200
- High integration with TI-RTOS with support for TI-RTOS Object View

IAR Embedded Workbench for ARM

- Integrated development environment with project management tools and editor
- IAR EWARM 7.30.3 and later has built-in support for the CC26xx device family
- Broad debugger support, supporting XDS100v3, XDS200, IAR I-Jet and Segger J-Link
- Integrated development environment with project management tools and editor
- RTOS plugin available for TI-RTOS

For a complete listing of development-support tools for the CC2640 platform, visit the Texas Instruments website at www.ti.com. For information on pricing and availability, contact the nearest TI field sales office or authorized distributor.

8.1.2 Device Nomenclature

To designate the stages in the product development cycle, TI assigns prefixes to all part numbers and/or date-code. Each device has one of three prefixes/identifications: X, P, or null (no prefix) (for example, CC2640 is in production; therefore, no prefix/identification is assigned).

Device development evolutionary flow:

- X** Experimental device that is not necessarily representative of the final device's electrical specifications and may not use production assembly flow.
- P** Prototype device that is not necessarily the final silicon die and may not necessarily meet final electrical specifications.
- null** Production version of the silicon die that is fully qualified.

Production devices have been characterized fully, and the quality and reliability of the device have been demonstrated fully. TI's standard warranty applies.

Predictions show that prototype devices (X or P) have a greater failure rate than the standard production devices. Texas Instruments recommends that these devices not be used in any production system because their expected end-use failure rate still is undefined. Only qualified production devices are to be used.

TI device nomenclature also includes a suffix with the device family name. This suffix indicates the package type (for example, *RSM*).

For orderable part numbers of *CC2640* devices in the *RSM*, *RHB* or *RGZ* package types, see the Package Option Addendum of this document, the TI website (www.ti.com), or contact your TI sales representative.

8.2 Documentation Support

The following documents describe the CC2640. Copies of these documents are available on the Internet at www.ti.com.

[SWCU117](#) *Technical Reference Manual*. Texas Instruments CC26xx Family of Products

[SWRS058](#) *Silicon Errata*. Texas Instruments CC26xx™ Family of Products

8.2.1 Community Resources

The following links connect to TI community resources. Linked contents are provided "AS IS" by the respective contributors. They do not constitute TI specifications and do not necessarily reflect TI's views; see TI's [Terms of Use](#).

[TI E2E™ Online Community](#) *TI's Engineer-to-Engineer (E2E) Community*. Created to foster collaboration among engineers. At e2e.ti.com, you can ask questions, share knowledge, explore ideas and help solve problems with fellow engineers.

[TI Embedded Processors Wiki](#) *Texas Instruments Embedded Processors Wiki*. Established to help developers get started with Embedded Processors from Texas Instruments and to foster innovation and growth of general knowledge about the hardware and software surrounding these devices.

8.3 Additional Information

Texas Instruments offers a wide selection of cost-effective, low-power RF solutions for proprietary and standard-based wireless applications for use in industrial and consumer applications. The selection includes RF transceivers, RF transmitters, RF front ends, and Systems-on-Chips as well as various software solutions for the sub-1-GHz and 2.4-GHz frequency bands.

In addition, Texas Instruments provides a large selection of support collateral such as development tools, technical documentation, reference designs, application expertise, customer support, third-party and university programs.

The Low-Power RF E2E Online Community provides technical support forums, videos and blogs, and the chance to interact with engineers from all over the world.

With a broad selection of product solutions, end-application possibilities, and a range of technical support, Texas Instruments offers the broadest low-power RF portfolio.

8.3.1 Texas Instruments Low-Power RF Website

Texas Instruments' Low-Power RF website has all the latest products, application and design notes, FAQ section, news and events updates. Go to www.ti.com/lprf.

8.3.2 Low-Power RF Online Community

- Forums, videos, and blogs
- RF design help
- E2E interaction

Join at: www.ti.com/lprf-forum.

8.3.3 Texas Instruments Low-Power RF Developer Network

Texas Instruments has launched an extensive network of low-power RF development partners to help customers speed up their application development. The network consists of recommended companies, RF consultants, and independent design houses that provide a series of hardware module products and design services, including:

- RF circuit, low-power RF, and ZigBee design services
- Low-power RF and ZigBee module solutions and development tools
- RF certification services and RF circuit manufacturing

For help with modules, engineering services or development tools:

Search the [Low-Power RF Developer Network](#) to find a suitable partner. www.ti.com/lprfnetwork

8.3.4 Low-Power RF eNewsletter

The Low-Power RF eNewsletter is up-to-date on new products, news releases, developers' news, and other news and events associated with low-power RF products from TI. The Low-Power RF eNewsletter articles include links to get more online information.

Sign up at: www.ti.com/lprfnewsletter

8.4 Trademarks

IAR Embedded Workbench is a registered trademark of IAR Systems AB.

SimpleLink, SmartRF, Code Composer Studio, CC26xx, E2E are trademarks of Texas Instruments.

ARM7 is a trademark of ARM Limited.

ARM, Cortex are registered trademarks of ARM Limited (or its subsidiaries).

ARM Thumb is a registered trademark of ARM Limited.

Bluetooth is a registered trademark of Bluetooth SIG, Inc.

CoreMark is a registered trademark of Embedded Microprocessor Benchmark Consortium.

IEEE Std 1241 is a trademark of Institute of Electrical and Electronics Engineers, Incorporated.

ZigBee is a registered trademark of ZigBee Alliance, Inc.

8.5 Electrostatic Discharge Caution



This integrated circuit can be damaged by ESD. Texas Instruments recommends that all integrated circuits be handled with appropriate precautions. Failure to observe proper handling and installation procedures can cause damage.

ESD damage can range from subtle performance degradation to complete device failure. Precision integrated circuits may be more susceptible to damage because very small parametric changes could cause the device not to meet its published specifications.

8.6 Export Control Notice

Recipient agrees to not knowingly export or re-export, directly or indirectly, any product or technical data (as defined by the U.S., EU, and other Export Administration Regulations) including software, or any controlled product restricted by other applicable national regulations, received from Disclosing party under this Agreement, or any direct product of such technology, to any destination to which such export or re-export is restricted or prohibited by U.S. or other applicable laws, without obtaining prior authorization from U.S. Department of Commerce and other competent Government authorities to the extent required by those laws.

8.7 Glossary

[SLYZ022](#) — *TI Glossary*.

This glossary lists and explains terms, acronyms and definitions.

9 Mechanical Packaging and Orderable Information

9.1 Packaging Information

The following pages include mechanical packaging and orderable information. This information is the most current data available for the designated devices. This data is subject to change without notice and revision of this document. For browser-based versions of this data sheet, refer to the left-hand navigation.

PACKAGING INFORMATION

Orderable Device	Status (1)	Package Type	Package Drawing	Pins	Package Qty	Eco Plan (2)	Lead/Ball Finish (6)	MSL Peak Temp (3)	Op Temp (°C)	Device Marking (4/5)	Samples
CC2640F128RGZR	ACTIVE	VQFN	RGZ	48	2500	Green (RoHS & no Sb/Br)	CU NIPDAU	Level-3-260C-168 HR	-40 to 85	CC2640 F128	Samples
CC2640F128RGZT	ACTIVE	VQFN	RGZ	48	250	Green (RoHS & no Sb/Br)	CU NIPDAU	Level-3-260C-168 HR	-40 to 85	CC2640 F128	Samples
CC2640F128RHBR	ACTIVE	VQFN	RHB	32		Green (RoHS & no Sb/Br)	CU NIPDAU	Level-3-260C-168 HR	-40 to 85	CC2640 F128	Samples

(1) The marketing status values are defined as follows:

ACTIVE: Product device recommended for new designs.

LIFEBUY: TI has announced that the device will be discontinued, and a lifetime-buy period is in effect.

NRND: Not recommended for new designs. Device is in production to support existing customers, but TI does not recommend using this part in a new design.

PREVIEW: Device has been announced but is not in production. Samples may or may not be available.

OBSOLETE: TI has discontinued the production of the device.

(2) Eco Plan - The planned eco-friendly classification: Pb-Free (RoHS), Pb-Free (RoHS Exempt), or Green (RoHS & no Sb/Br) - please check <http://www.ti.com/productcontent> for the latest availability information and additional product content details.

TBD: The Pb-Free/Green conversion plan has not been defined.

Pb-Free (RoHS): TI's terms "Lead-Free" or "Pb-Free" mean semiconductor products that are compatible with the current RoHS requirements for all 6 substances, including the requirement that lead not exceed 0.1% by weight in homogeneous materials. Where designed to be soldered at high temperatures, TI Pb-Free products are suitable for use in specified lead-free processes.

Pb-Free (RoHS Exempt): This component has a RoHS exemption for either 1) lead-based flip-chip solder bumps used between the die and package, or 2) lead-based die adhesive used between the die and leadframe. The component is otherwise considered Pb-Free (RoHS compatible) as defined above.

Green (RoHS & no Sb/Br): TI defines "Green" to mean Pb-Free (RoHS compatible), and free of Bromine (Br) and Antimony (Sb) based flame retardants (Br or Sb do not exceed 0.1% by weight in homogeneous material)

(3) MSL, Peak Temp. - The Moisture Sensitivity Level rating according to the JEDEC industry standard classifications, and peak solder temperature.

(4) There may be additional marking, which relates to the logo, the lot trace code information, or the environmental category on the device.

(5) Multiple Device Markings will be inside parentheses. Only one Device Marking contained in parentheses and separated by a "~" will appear on a device. If a line is indented then it is a continuation of the previous line and the two combined represent the entire Device Marking for that device.

(6) Lead/Ball Finish - Orderable Devices may have multiple material finish options. Finish options are separated by a vertical ruled line. Lead/Ball Finish values may wrap to two lines if the finish value exceeds the maximum column width.

Important Information and Disclaimer: The information provided on this page represents TI's knowledge and belief as of the date that it is provided. TI bases its knowledge and belief on information provided by third parties, and makes no representation or warranty as to the accuracy of such information. Efforts are underway to better integrate information from third parties. TI has taken and

continues to take reasonable steps to provide representative and accurate information but may not have conducted destructive testing or chemical analysis on incoming materials and chemicals. TI and TI suppliers consider certain information to be proprietary, and thus CAS numbers and other limited information may not be available for release.

In no event shall TI's liability arising out of such information exceed the total purchase price of the TI part(s) at issue in this document sold by TI to Customer on an annual basis.

TAPE AND REEL INFORMATION

QUADRANT ASSIGNMENTS FOR PIN 1 ORIENTATION IN TAPE

*All dimensions are nominal

Device	Package Type	Package Drawing	Pins	SPQ	Reel Diameter (mm)	Reel Width W1 (mm)	A0 (mm)	B0 (mm)	K0 (mm)	P1 (mm)	W (mm)	Pin1 Quadrant
CC2640F128RGZR	VQFN	RGZ	48	2500	330.0	16.4	7.3	7.3	1.1	12.0	16.0	Q2
CC2640F128RGZT	VQFN	RGZ	48	250	180.0	16.4	7.3	7.3	1.1	12.0	16.0	Q2

TAPE AND REEL BOX DIMENSIONS

*All dimensions are nominal

Device	Package Type	Package Drawing	Pins	SPQ	Length (mm)	Width (mm)	Height (mm)
CC2640F128RGZR	VQFN	RGZ	48	2500	367.0	367.0	38.0
CC2640F128RGZT	VQFN	RGZ	48	250	210.0	185.0	35.0

RGZ (S-PVQFN-N48)

PLASTIC QUAD FLATPACK NO-LEAD

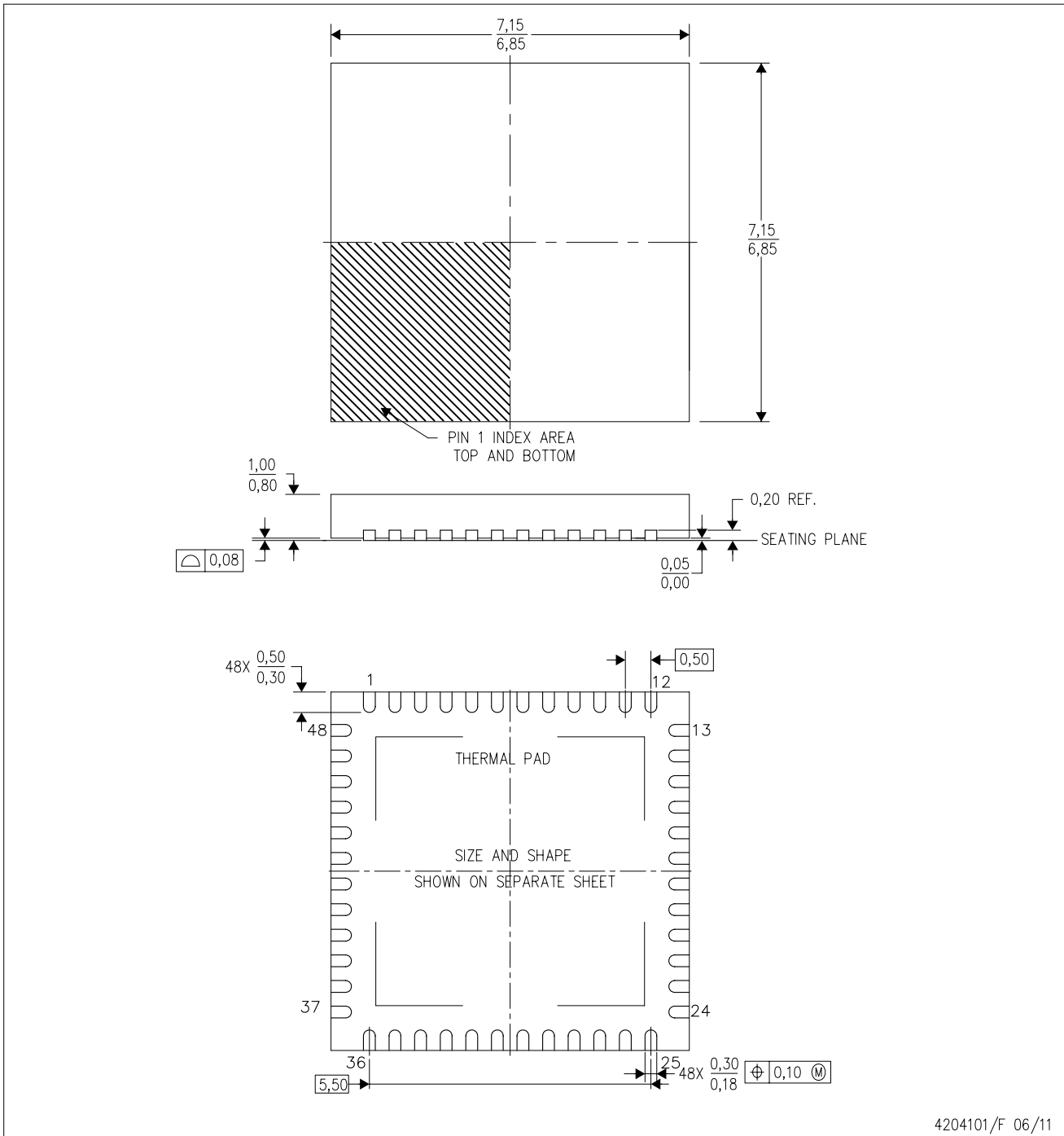

4204101/F 06/11

- NOTES:
- A. All linear dimensions are in millimeters. Dimensioning and tolerancing per ASME Y14.5M-1994.
 - B. This drawing is subject to change without notice.
 - C. Quad Flatpack, No-leads (QFN) package configuration.
 - D. The package thermal pad must be soldered to the board for thermal and mechanical performance.
 - E. See the additional figure in the Product Data Sheet for details regarding the exposed thermal pad features and dimensions.
 - F. Falls within JEDEC MO-220.

THERMAL INFORMATION

This package incorporates an exposed thermal pad that is designed to be attached directly to an external heatsink. The thermal pad must be soldered directly to the printed circuit board (PCB). After soldering, the PCB can be used as a heatsink. In addition, through the use of thermal vias, the thermal pad can be attached directly to the appropriate copper plane shown in the electrical schematic for the device, or alternatively, can be attached to a special heatsink structure designed into the PCB. This design optimizes the heat transfer from the integrated circuit (IC).

For information on the Quad Flatpack No-Lead (QFN) package and its advantages, refer to Application Report, QFN/SON PCB Attachment, Texas Instruments Literature No. SLUA271. This document is available at www.ti.com.

The exposed thermal pad dimensions for this package are shown in the following illustration.

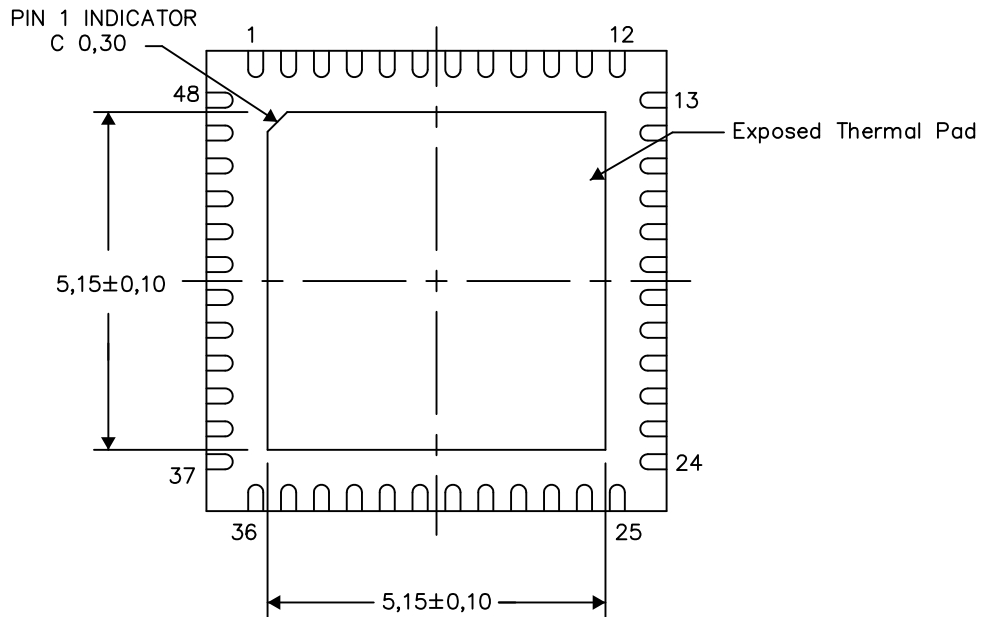

Bottom View

Exposed Thermal Pad Dimensions

4206354-2/Y 06/14

NOTE: All linear dimensions are in millimeters

RGZ (S-PVQFN-N48)

PLASTIC QUAD FLATPACK NO-LEAD

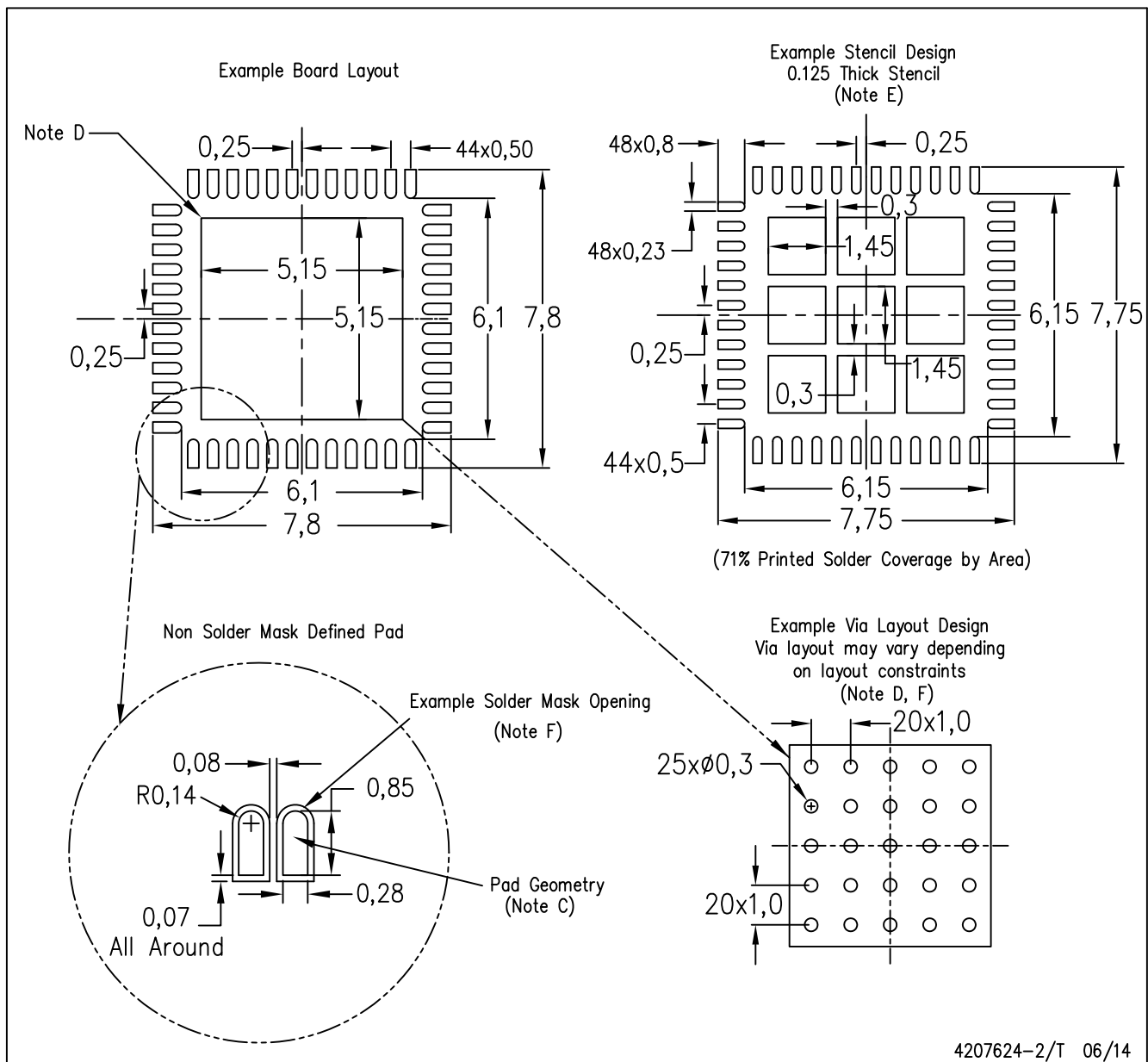

- NOTES:
- All linear dimensions are in millimeters.
 - This drawing is subject to change without notice.
 - Publication IPC-7351 is recommended for alternate designs.
 - This package is designed to be soldered to a thermal pad on the board. Refer to Application Note, Quad Flat-Pack Packages, Texas Instruments Literature No. SLUA271, and also the Product Data Sheets for specific thermal information, via requirements, and recommended board layout. These documents are available at www.ti.com <<http://www.ti.com>>.
 - Laser cutting apertures with trapezoidal walls and also rounding corners will offer better paste release. Customers should contact their board assembly site for stencil design recommendations. Refer to IPC 7525 for stencil design considerations.
 - Customers should contact their board fabrication site for recommended solder mask tolerances and via tenting recommendations for vias placed in the thermal pad.

MECHANICAL DATA

RHB (S-PVQFN-N32)

PLASTIC QUAD FLATPACK NO-LEAD

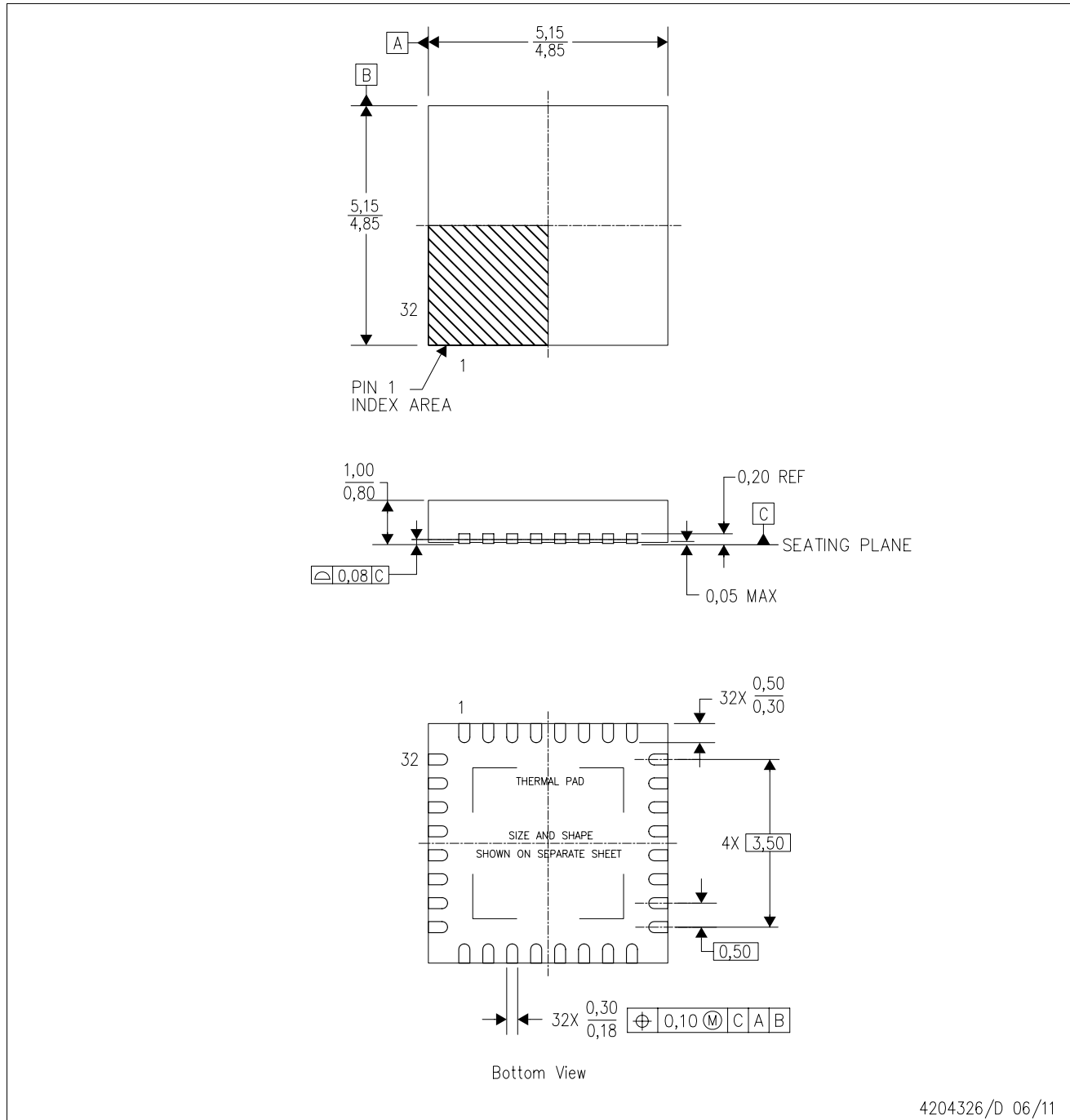

- NOTES:
- All linear dimensions are in millimeters. Dimensioning and tolerancing per ASME Y14.5M-1994.
 - This drawing is subject to change without notice.
 - QFN (Quad Flatpack No-Lead) Package configuration.
 - The package thermal pad must be soldered to the board for thermal and mechanical performance.
 - See the additional figure in the Product Data Sheet for details regarding the exposed thermal pad features and dimensions.
 - Falls within JEDEC MO-220.

THERMAL INFORMATION

This package incorporates an exposed thermal pad that is designed to be attached directly to an external heatsink. The thermal pad must be soldered directly to the printed circuit board (PCB). After soldering, the PCB can be used as a heatsink. In addition, through the use of thermal vias, the thermal pad can be attached directly to the appropriate copper plane shown in the electrical schematic for the device, or alternatively, can be attached to a special heatsink structure designed into the PCB. This design optimizes the heat transfer from the integrated circuit (IC).

For information on the Quad Flatpack No-Lead (QFN) package and its advantages, refer to Application Report, QFN/SON PCB Attachment, Texas Instruments Literature No. SLUA271. This document is available at www.ti.com.

The exposed thermal pad dimensions for this package are shown in the following illustration.

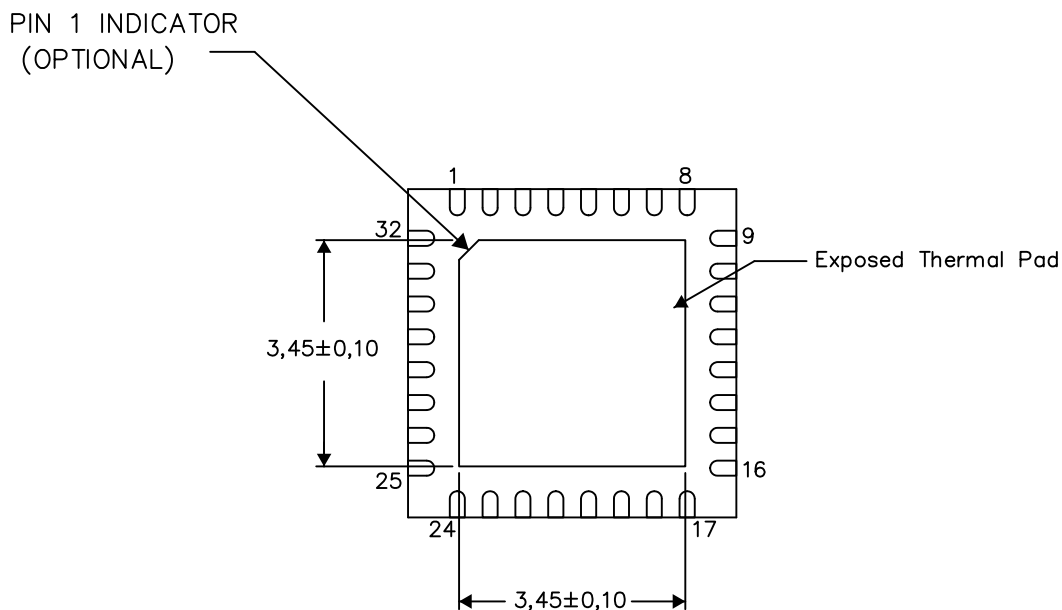

Bottom View

Exposed Thermal Pad Dimensions

4206356-2/AB 07/14

NOTE: A. All linear dimensions are in millimeters

RHB (S-PVQFN-N32)

PLASTIC QUAD FLATPACK NO-LEAD

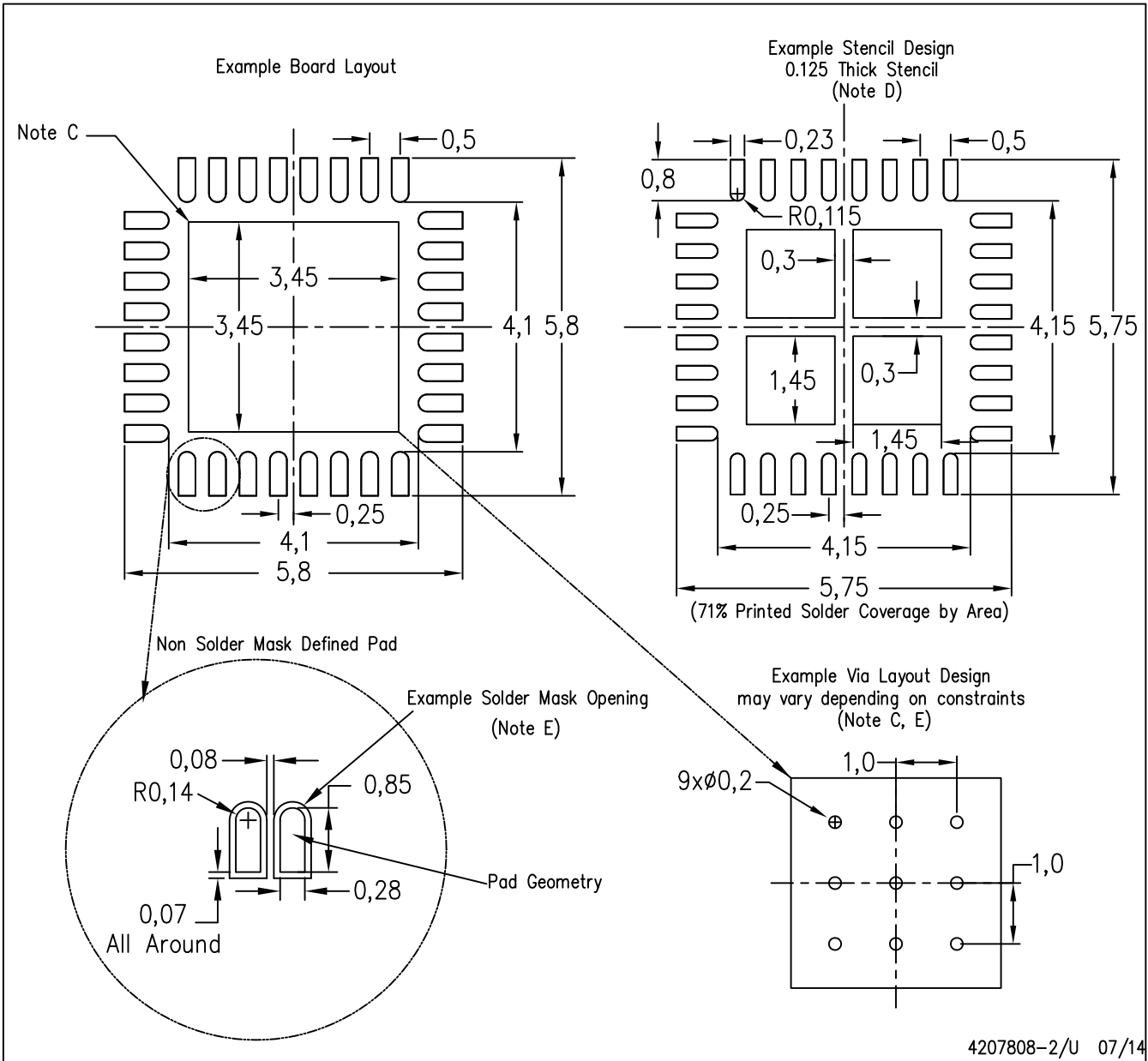

4207808-2/U 07/14

- NOTES:
- All linear dimensions are in millimeters.
 - This drawing is subject to change without notice.
 - This package is designed to be soldered to a thermal pad on the board. Refer to Application Note, Quad Flat-Pack Packages, Texas Instruments Literature No. SLUA271, and also the Product Data Sheets for specific thermal information, via requirements, and recommended board layout. These documents are available at www.ti.com <<http://www.ti.com>>.
 - Laser cutting apertures with trapezoidal walls and also rounding corners will offer better paste release. Customers should contact their board assembly site for stencil design recommendations. Refer to IPC 7525 for stencil design considerations.
 - Customers should contact their board fabrication site for recommended solder mask tolerances and via tenting recommendations for any larger diameter vias placed in the thermal pad.

RSM (S-PVQFN-N32)

PLASTIC QUAD FLATPACK NO-LEAD

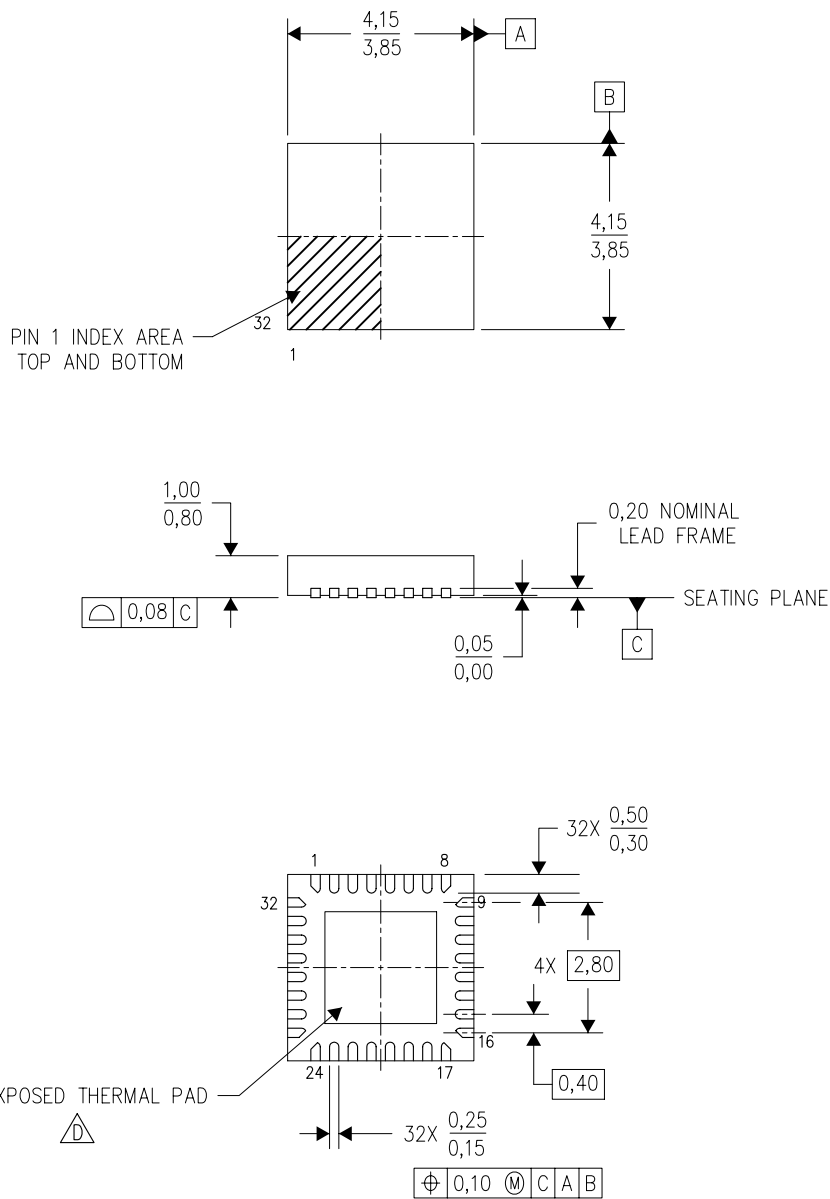

4207560/B 03/10

- NOTES:
- A. All linear dimensions are in millimeters. Dimensioning and tolerancing per ASME Y14.5M-1994.
 - B. This drawing is subject to change without notice.
 - C. QFN (Quad Flatpack No-Lead) Package configuration.
 -  The package thermal pad must be soldered to the board for thermal and mechanical performance. See the Product Data Sheet for details regarding the exposed thermal pad dimensions.

RSM (S-PVQFN-N32)

PLASTIC QUAD FLATPACK NO-LEAD

THERMAL INFORMATION

This package incorporates an exposed thermal pad that is designed to be attached directly to an external heatsink. The thermal pad must be soldered directly to the printed circuit board (PCB). After soldering, the PCB can be used as a heatsink. In addition, through the use of thermal vias, the thermal pad can be attached directly to the appropriate copper plane shown in the electrical schematic for the device, or alternatively, can be attached to a special heatsink structure designed into the PCB. This design optimizes the heat transfer from the integrated circuit (IC).

For information on the Quad Flatpack No-Lead (QFN) package and its advantages, refer to Application Report, QFN/SON PCB Attachment, Texas Instruments Literature No. SLUA271. This document is available at www.ti.com.

The exposed thermal pad dimensions for this package are shown in the following illustration.

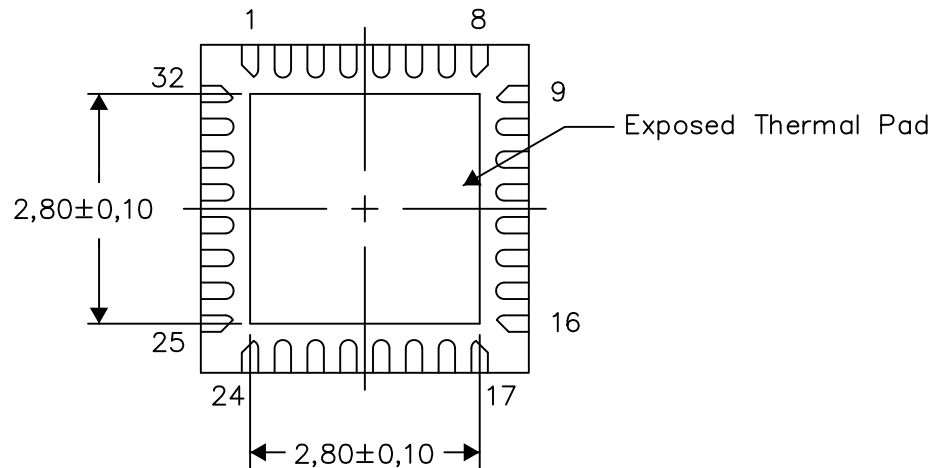

Bottom View

Exposed Thermal Pad Dimensions

4207868-2/1 07/14

NOTE: All linear dimensions are in millimeters

RSM (S-PVQFN-N32)

PLASTIC QUAD FLATPACK NO-LEAD

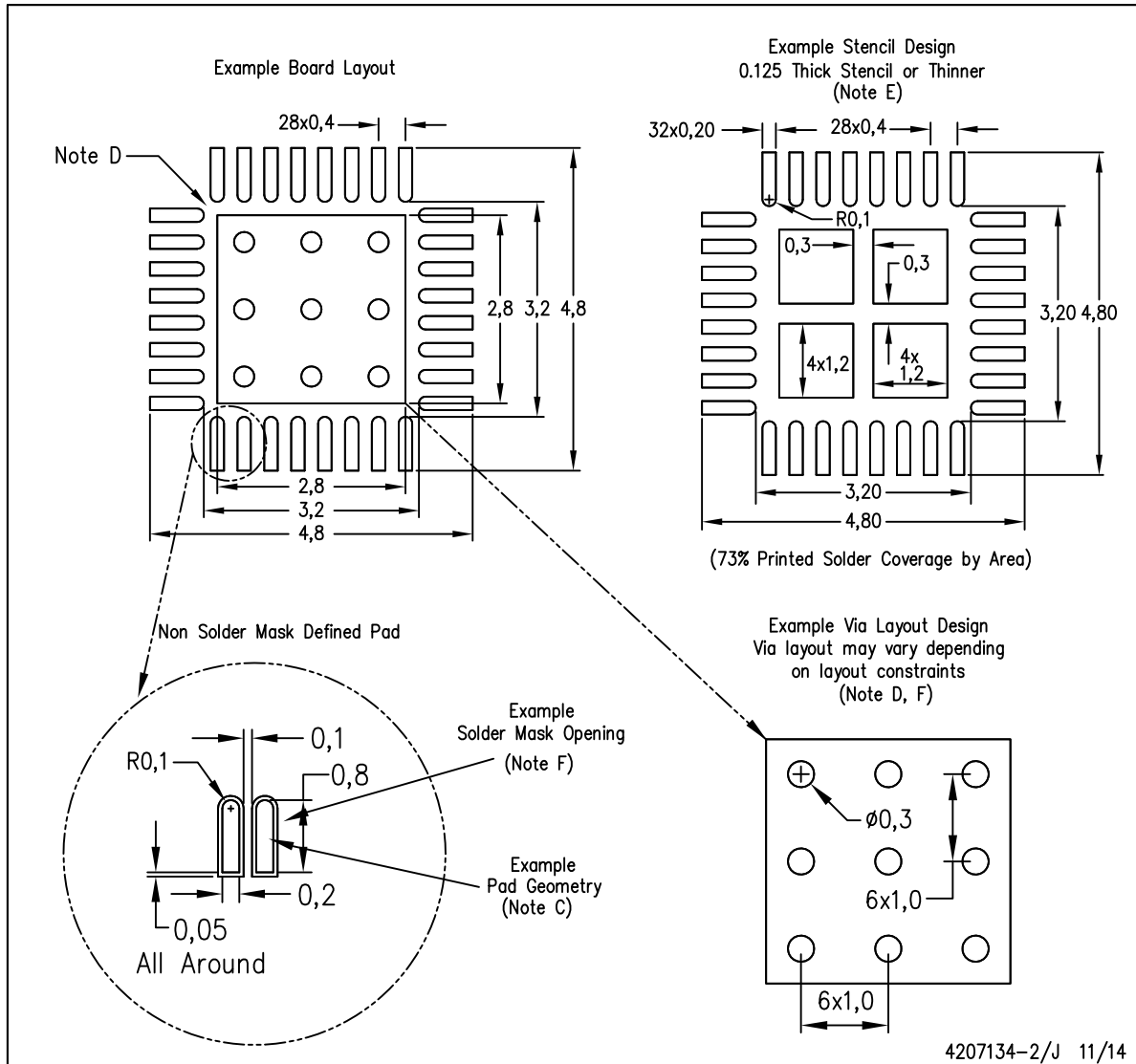

- NOTES:
- A. All linear dimensions are in millimeters.
 - B. This drawing is subject to change without notice.
 - C. Publication IPC-7351 is recommended for alternate designs.
 - D. This package is designed to be soldered to a thermal pad on the board. Refer to Application Note, Quad Flat-Pack Packages, Texas Instruments Literature No. SLUA271, and also the Product Data Sheets for specific thermal information, via requirements, and recommended board layout. These documents are available at www.ti.com <<http://www.ti.com>>.
 - E. Laser cutting apertures with trapezoidal walls and also rounding corners will offer better paste release. Customers should contact their board assembly site for stencil design recommendations. Refer to IPC 7525 for stencil design considerations.
 - F. Customers should contact their board fabrication site for recommended solder mask tolerances and via tenting recommendations for vias placed in the thermal pad.

IMPORTANT NOTICE

Texas Instruments Incorporated and its subsidiaries (TI) reserve the right to make corrections, enhancements, improvements and other changes to its semiconductor products and services per JESD46, latest issue, and to discontinue any product or service per JESD48, latest issue. Buyers should obtain the latest relevant information before placing orders and should verify that such information is current and complete. All semiconductor products (also referred to herein as "components") are sold subject to TI's terms and conditions of sale supplied at the time of order acknowledgment.

TI warrants performance of its components to the specifications applicable at the time of sale, in accordance with the warranty in TI's terms and conditions of sale of semiconductor products. Testing and other quality control techniques are used to the extent TI deems necessary to support this warranty. Except where mandated by applicable law, testing of all parameters of each component is not necessarily performed.

TI assumes no liability for applications assistance or the design of Buyers' products. Buyers are responsible for their products and applications using TI components. To minimize the risks associated with Buyers' products and applications, Buyers should provide adequate design and operating safeguards.

TI does not warrant or represent that any license, either express or implied, is granted under any patent right, copyright, mask work right, or other intellectual property right relating to any combination, machine, or process in which TI components or services are used. Information published by TI regarding third-party products or services does not constitute a license to use such products or services or a warranty or endorsement thereof. Use of such information may require a license from a third party under the patents or other intellectual property of the third party, or a license from TI under the patents or other intellectual property of TI.

Reproduction of significant portions of TI information in TI data books or data sheets is permissible only if reproduction is without alteration and is accompanied by all associated warranties, conditions, limitations, and notices. TI is not responsible or liable for such altered documentation. Information of third parties may be subject to additional restrictions.

Resale of TI components or services with statements different from or beyond the parameters stated by TI for that component or service voids all express and any implied warranties for the associated TI component or service and is an unfair and deceptive business practice. TI is not responsible or liable for any such statements.

Buyer acknowledges and agrees that it is solely responsible for compliance with all legal, regulatory and safety-related requirements concerning its products, and any use of TI components in its applications, notwithstanding any applications-related information or support that may be provided by TI. Buyer represents and agrees that it has all the necessary expertise to create and implement safeguards which anticipate dangerous consequences of failures, monitor failures and their consequences, lessen the likelihood of failures that might cause harm and take appropriate remedial actions. Buyer will fully indemnify TI and its representatives against any damages arising out of the use of any TI components in safety-critical applications.

In some cases, TI components may be promoted specifically to facilitate safety-related applications. With such components, TI's goal is to help enable customers to design and create their own end-product solutions that meet applicable functional safety standards and requirements. Nonetheless, such components are subject to these terms.

No TI components are authorized for use in FDA Class III (or similar life-critical medical equipment) unless authorized officers of the parties have executed a special agreement specifically governing such use.

Only those TI components which TI has specifically designated as military grade or "enhanced plastic" are designed and intended for use in military/aerospace applications or environments. Buyer acknowledges and agrees that any military or aerospace use of TI components which have **not** been so designated is solely at the Buyer's risk, and that Buyer is solely responsible for compliance with all legal and regulatory requirements in connection with such use.

TI has specifically designated certain components as meeting ISO/TS16949 requirements, mainly for automotive use. In any case of use of non-designated products, TI will not be responsible for any failure to meet ISO/TS16949.

Products

Audio	www.ti.com/audio
Amplifiers	amplifier.ti.com
Data Converters	dataconverter.ti.com
DLP® Products	www.dlp.com
DSP	dsp.ti.com
Clocks and Timers	www.ti.com/clocks
Interface	interface.ti.com
Logic	logic.ti.com
Power Mgmt	power.ti.com
Microcontrollers	microcontroller.ti.com
RFID	www.ti-rfid.com
OMAP Applications Processors	www.ti.com/omap
Wireless Connectivity	www.ti.com/wirelessconnectivity

Applications

Automotive and Transportation	www.ti.com/automotive
Communications and Telecom	www.ti.com/communications
Computers and Peripherals	www.ti.com/computers
Consumer Electronics	www.ti.com/consumer-apps
Energy and Lighting	www.ti.com/energy
Industrial	www.ti.com/industrial
Medical	www.ti.com/medical
Security	www.ti.com/security
Space, Avionics and Defense	www.ti.com/space-avionics-defense
Video and Imaging	www.ti.com/video

TI E2E Community

e2e.ti.com